



Tip	Hatve	Diş Yüksekliği	Toplam Yükseklik	Ağırlık/mt/mm
T2.5	2.50 mm	0.70 mm	1.30 mm	0.0015 KG
T5	5.00 mm	1.20 mm	2.20 mm	0.0025 KG
T10	10.00 mm	2.50 mm	4.50 mm	0.0455 KG
T20	20.00 mm	5.00 mm	8.00 mm	0.0080 KG
AT5	5.00 mm	1.20 mm	2.70 mm	0.0030 KG
AT10	10.00mm	2.50 mm	5.00 mm	0.0060 KG
AT20	20.00 mm	5.00 mm	8.00 mm	0.0110 KG
MXL	2.032 mm	0.510 mm	1.140 mm	0.0009 KG
XL	5.080 mm	1.270 mm	2.300 mm	0.0020 KG
L	9.525 mm	1.910 mm	3.600 mm	0.0024 KG
H	12.700 mm	2.290 mm	4.300 mm	0.0028 KG
XH	22.225 mm	6.350 mm	11.200 mm	0.0128 KG
XXH	31.750 mm	9.530 mm	15.700 mm	0.0230 KG
2M	2.00 mm	0.75 mm	1.36 mm	0.0018 KG
3M	3.00 mm	1.17 mm	2.40 mm	0.0026 KG
5M	5.00 mm	2.06 mm	3.80 mm	0.0048 KG
8M	8.00 mm	3.36 mm	6.00 mm	0.0069 KG
14M	14.00 mm	6.02 mm	10.00 mm	0.0110 KG
20M	20.00 mm	8.40 mm	13.20 mm	0.0210 KG
S2M	2.00 mm	0.76 mm	1.36 mm	0.0018 KG
S3M	3.00 mm	1.14 mm	1.90 mm	0.0026 KG
S4.5M	4.50 mm	1.71 mm	2.81 mm	0.0042 KG
S5M	5.00 mm	1.91 mm	3.40 mm	0.0048 KG
S8M	8.00 mm	3.05 mm	5.30 mm	0.0069 KG
S14M	14.00 mm	6.00 mm	10.00 mm	0.0110 KG
RPP2M	2.00 mm	0.76 mm	1.36 mm	0.0018 KG
RPP3M	3.00 mm	1.15 mm	1.90 mm	0.0026 KG
RPP5M	5.00 mm	1.95 mm	3.50 mm	0.0048 KG
RPP8M	8.00 mm	3.20 mm	5.50 mm	0.0069 KG
RPP14M	14.00 mm	6.00 mm	10.00 mm	0.0110 KG

BEIDI Zaman Kayışı 8M 1000 50

Tip/Kod _____

Kayış Uzunluğu mm _____

Genişlik mm _____

BEIDI çift taraflı zaman kayışları
içinde soldaki listeyi baz alınız.
Ağırlık bilgisi için 1.4 ile
çarpabilirsiniz.

KAUÇUK ZAMAN KAYIŞLARI

MXL (2/25" 2,032mm)

USD

TİP TYPE	DİŞ TEETH	ÇEVRE LENGTH	1 MM	TİP TYPE	DİŞ TEETH	ÇEVRE LENGTH	1 MM	TİP TYPE	DİŞ TEETH	ÇEVRE LENGTH	1 MM
288 MXL	36	73.15	***	776 MXL	97	197.10	***	1272 MXL	159	323.09	***
320 MXL	40	81.28	***	784 MXL	98	199.14	***	1280 MXL	160	325.12	***
328 MXL	41	83.31	***	792 MXL	99	201.17	***	1296 MXL	162	329.18	***
344 MXL	43	87.38	***	800 MXL	100	203.20	***	1312 MXL	164	333.25	***
360 MXL	45	91.44	***	808 MXL	101	205.23	***	1320 MXL	165	335.28	***
392 MXL	49	99.57	***	816 MXL	102	207.26	***	1352 MXL	169	343.41	***
400 MXL	50	101.60	***	824 MXL	103	209.30	***	1360 MXL	170	345.44	***
416 MXL	52	105.66	***	832 MXL	104	211.33	***	1400 MXL	175	355.60	***
424 MXL	53	107.70	***	840 MXL	105	213.36	***	1416 MXL	177	359.66	***
432 MXL	54	109.73	***	848 MXL	106	215.39	***	1440 MXL	180	365.76	***
440 MXL	55	111.76	***	864 MXL	108	219.46	***	1472 MXL	184	373.89	***
448 MXL	56	113.79	***	872 MXL	109	221.49	***	1504 MXL	188	382.02	***
456 MXL	57	115.82	***	880 MXL	110	223.52	***	1520 MXL	190	386.08	***
464 MXL	58	117.86	***	896 MXL	112	227.58	***	1536 MXL	192	390.14	***
472 MXL	59	119.89	***	904 MXL	113	229.62	***	1552 MXL	194	394.21	***
480 MXL	60	121.92	***	912 MXL	114	231.65	***	1560 MXL	195	396.24	***
488 MXL	61	123.95	***	920 MXL	115	233.68	***	1568 MXL	196	398.27	***
496 MXL	62	125.98	***	928 MXL	116	235.71	***	1600 MXL	200	406.40	***
504 MXL	63	128.02	***	944 MXL	118	239.78	***	1632 MXL	204	414.53	***
512 MXL	64	130.05	***	952 MXL	119	241.81	***	1640 MXL	205	416.56	***
520 MXL	65	132.08	***	960 MXL	120	243.84	***	1680 MXL	210	426.72	***
528 MXL	66	134.11	***	968 MXL	121	245.87	***	1696 MXL	212	430.78	***
536 MXL	67	136.14	***	976 MXL	122	247.90	***	1720 MXL	215	436.88	***
544 MXL	68	138.18	***	984 MXL	123	249.94	***	1752 MXL	219	445.01	***
552 MXL	69	140.21	***	992 MXL	124	251.97	***	1760 MXL	220	447.04	***
560 MXL	70	142.24	***	1000 MXL	125	254.00	***	1768 MXL	221	449.07	***
568 MXL	71	144.27	***	1008 MXL	126	256.03	***	1776 MXL	222	451.10	***
576 MXL	72	146.30	***	1016 MXL	127	258.06	***	1792 MXL	224	455.17	***
584 MXL	73	148.34	***	1024 MXL	128	260.10	***	1800 MXL	225	457.20	***
592 MXL	74	150.37	***	1032 MXL	129	262.13	***	1808 MXL	226	459.23	***
600 MXL	75	152.40	***	1040 MXL	130	264.16	***	1824 MXL	228	463.30	***
608 MXL	76	154.43	***	1048 MXL	131	266.19	***	1840 MXL	230	467.36	***
616 MXL	77	156.46	***	1056 MXL	132	268.22	***	1856 MXL	232	471.42	***
624 MXL	78	158.50	***	1064 MXL	133	270.26	***	1872 MXL	234	475.49	***
632 MXL	79	160.53	***	1080 MXL	135	274.32	***	1880 MXL	235	477.52	***
640 MXL	80	162.56	***	1096 MXL	137	278.38	***	1888 MXL	236	479.55	***
656 MXL	82	166.62	***	1104 MXL	138	280.42	***	1912 MXL	239	485.65	***
664 MXL	83	168.66	***	1120 MXL	140	284.48	***	1920 MXL	240	487.68	***
680 MXL	85	172.72	***	1128 MXL	141	286.51	***	1960 MXL	245	497.84	***
688 MXL	86	174.75	***	1136 MXL	142	288.54	***	1984 MXL	248	503.94	***
696 MXL	87	176.78	***	1152 MXL	144	292.61	***	1992 MXL	249	505.97	***
704 MXL	88	178.82	***	1160 MXL	145	294.64	***	2000 MXL	250	508.00	***
712 MXL	89	180.85	***	1168 MXL	146	296.67	***	2008 MXL	251	510.03	***
720 MXL	90	182.88	***	1176 MXL	147	298.70	***	2040 MXL	255	518.16	***
728 MXL	91	184.91	***	1184 MXL	148	300.74	***	2048 MXL	256	520.19	***
736 MXL	92	186.94	***	1200 MXL	150	304.80	***	2080 MXL	260	528.32	***
744 MXL	93	188.98	***	1208 MXL	151	306.83	***	2096 MXL	262	532.38	***
752 MXL	94	191.01	***	1224 MXL	153	310.90	***	2120 MXL	265	538.48	***
760 MXL	95	193.04	***	1240 MXL	155	314.96	***	2144 MXL	268	544.58	***
768 MXL	96	195.07	***	1264 MXL	158	321.06	***	2168 MXL	271	550.67	***

KAUÇUK ZAMAN KAYIŞLARI

MXL (2/25" 2,032mm)

USD

TİP TYPE	DİŞ TEETH	ÇEVRE LENGTH	1 MM	TİP TYPE	DİŞ TEETH	ÇEVRE LENGTH	1 MM	TİP TYPE	DİŞ TEETH	ÇEVRE LENGTH	1 MM
2184 MXL	273	554.74	***	3240 MXL	405	822.96	***	5600 MXL	700	1422.40	***
2200 MXL	275	558.80	***	3280 MXL	410	833.12	***	5760 MXL	720	1463.04	***
2208 MXL	276	560.83	***	3304 MXL	413	839.22	***	5808 MXL	726	1475.23	***
2240 MXL	280	568.96	***	3360 MXL	420	853.44	***	6000 MXL	750	1524.00	***
2248 MXL	281	570.99	***	3400 MXL	425	863.60	***	6080 MXL	760	1544.32	***
2280 MXL	285	579.12	***	3440 MXL	430	873.76	***	6096 MXL	762	1548.38	***
2304 MXL	288	585.22	***	3448 MXL	431	875.79	***	6208 MXL	776	1576.83	***
2320 MXL	290	589.28	***	3472 MXL	434	881.89	***	6400 MXL	800	1625.60	***
2360 MXL	295	599.44	***	3480 MXL	435	883.92	***	6440 MXL	805	1635.76	***
2376 MXL	297	603.50	***	3520 MXL	440	894.08	***	7200 MXL	900	1828.80	***
2384 MXL	298	605.54	***	3584 MXL	448	910.34	***	7248 MXL	906	1840.99	***
2400 MXL	300	609.60	***	3600 MXL	450	914.40	***	7440 MXL	930	1889.76	***
2440 MXL	305	619.76	***	3624 MXL	453	920.50	***	8000 MXL	1000	2032.00	***
2464 MXL	308	625.86	***	3680 MXL	460	934.72	***	8096 MXL	1012	2056.38	***
2480 MXL	310	629.92	***	3712 MXL	464	942.85	***	8480 MXL	1060	2153.92	***
2496 MXL	312	633.98	***	3744 MXL	468	950.98	***	8608 MXL	1076	2186.43	***
2520 MXL	315	640.08	***	3760 MXL	470	955.04	***	8624 MXL	1078	2190.50	***
2544 MXL	318	646.18	***	3784 MXL	473	961.14	***	8704 MXL	1088	2210.82	***
2560 MXL	320	650.24	***	3800 MXL	475	965.20	***	8800 MXL	1100	2235.20	***
2584 MXL	323	656.34	***	3840 MXL	480	975.36	***	9096 MXL	1137	2310.38	***
2608 MXL	326	662.43	***	3896 MXL	487	989.58	***	9328 MXL	1166	2369.31	***
2624 MXL	328	666.50	***	3920 MXL	490	995.68	***	9600 MXL	1200	2438.40	***
2640 MXL	330	670.56	***	3944 MXL	493	1001.78	***	10000 MXL	1250	2540.00	***
2656 MXL	332	674.62	***	3984 MXL	498	1011.94	***	10400 MXL	1300	2641.60	***
2664 MXL	333	676.66	***	4000 MXL	500	1016.00	***	10800 MXL	1350	2743.20	***
2672 MXL	334	678.69	***	4032 MXL	504	1024.13	***	11040 MXL	1380	2804.16	***
2688 MXL	336	682.75	***	4080 MXL	510	1036.32	***	11136 MXL	1392	2828.54	***
2696 MXL	337	684.78	***	4128 MXL	516	1048.51	***	11200 MXL	1400	2844.80	***
2720 MXL	340	690.88	***	4160 MXL	520	1056.64	***	11408 MXL	1426	2897.63	***
2760 MXL	345	701.04	***	4176 MXL	522	1060.70	***	11704 MXL	1463	2972.82	***
2776 MXL	347	705.10	***	4192 MXL	524	1064.77	***	12000 MXL	1500	3048.00	***
2800 MXL	350	711.20	***	4200 MXL	525	1066.80	***	12128 MXL	1516	3080.51	***
2832 MXL	354	719.33	***	4240 MXL	530	1076.96	***	12160 MXL	1520	3088.64	***
2840 MXL	355	721.36	***	4280 MXL	535	1087.12	***	14224 MXL	1778	3612.90	***
2864 MXL	358	727.46	***	4320 MXL	540	1097.28	***				
2872 MXL	359	729.49	***	4400 MXL	550	1117.60	***				
2880 MXL	360	731.52	***	4480 MXL	560	1137.92	***				
2912 MXL	364	739.65	***	4560 MXL	570	1158.24	***				
2920 MXL	365	741.68	***	4640 MXL	580	1178.56	***				
2960 MXL	370	751.84	***	4664 MXL	583	1184.66	***				
2968 MXL	371	753.87	***	4720 MXL	590	1198.88	***				
2976 MXL	372	755.90	***	4728 MXL	591	1200.91	***				
3000 MXL	375	762.00	***	4800 MXL	600	1219.20	***				
3024 MXL	378	768.10	***	4896 MXL	612	1243.58	***				
3040 MXL	380	772.16	***	4960 MXL	620	1259.84	***				
3104 MXL	388	788.42	***	5120 MXL	640	1300.48	***				
3120 MXL	390	792.48	***	5184 MXL	648	1316.74	***				
3176 MXL	397	806.70	***	5320 MXL	665	1351.28	***				
3200 MXL	400	812.80	***	5360 MXL	670	1361.44	***				
3216 MXL	402	816.86	***	5440 MXL	680	1381.76	***				

KAUÇUK ZAMAN KAYIŞLARI

XL (1/5" 5,08 mm)

USD

TİP TYPE	DİŞ TEETH	ÇEVRE LENGTH	1 MM	TİP TYPE	DİŞ TEETH	ÇEVRE LENGTH	1 MM	TİP TYPE	DİŞ TEETH	ÇEVRE LENGTH	1 MM
44 XL	22	111.8		158 XL	79	401.3		276 XL	138	701.0	
50 XL	25	127.0		160 XL	80	406.4		280 XL	140	711.2	
54 XL	27	137.2		162 XL	81	411.5		282 XL	141	716.3	
60 XL	30	152.4		164 XL	82	416.6		286 XL	143	726.4	
64 XL	32	162.6		166 XL	83	421.6		290 XL	145	736.6	
68 XL	34	172.7		168 XL	84	426.7		296 XL	148	751.8	
70 XL	35	177.8		170 XL	85	431.8		300 XL	150	762.0	
72 XL	36	182.9		172 XL	86	436.9		304 XL	152	772.2	
74 XL	37	188.0		174 XL	87	442.0		306 XL	153	777.2	
76 XL	38	193.0		176 XL	88	447.0		310 XL	155	787.4	
78 XL	39	198.1		178 XL	89	452.1		312 XL	156	792.5	
80 XL	40	203.2		180 XL	90	457.2		314 XL	157	797.6	
82 XL	41	208.3		182 XL	91	462.3		316 XL	158	802.6	
84 XL	42	213.4		184 XL	92	467.4		320 XL	160	812.8	
86 XL	43	218.4		186 XL	93	472.4		322 XL	161	817.9	
88 XL	44	223.5		188 XL	94	477.5		326 XL	163	828.0	
90 XL	45	228.6		190 XL	95	482.6		330 XL	165	838.2	
92 XL	46	233.7		192 XL	96	487.7		336 XL	168	853.4	
94 XL	47	238.8		194 XL	97	492.8		340 XL	170	863.6	
96 XL	48	243.8		196 XL	98	497.8		344 XL	172	873.8	
98 XL	49	248.9		198 XL	99	502.9		348 XL	174	883.9	
100 XL	50	254.0		200 XL	100	508.0		350 XL	175	889.0	
102 XL	51	259.1		202 XL	101	513.1		352 XL	176	894.1	
104 XL	52	264.2		204 XL	102	518.2		356 XL	178	904.2	
106 XL	53	269.2		206 XL	103	523.2		360 XL	180	914.4	
108 XL	54	274.3		208 XL	104	528.3		364 XL	182	924.6	
110 XL	55	279.4		210 XL	105	533.4		370 XL	185	939.8	
112 XL	56	284.5		212 XL	106	538.5		372 XL	186	944.9	
114 XL	57	289.6		214 XL	107	543.6		376 XL	188	955.0	
116 XL	58	294.6		216 XL	108	548.6		380 XL	190	965.2	
118 XL	59	299.7		218 XL	109	553.7		382 XL	191	970.3	
120 XL	60	304.8		220 XL	110	558.8		384 XL	192	975.4	
122 XL	61	309.9		222 XL	111	563.9		386 XL	193	980.4	
124 XL	62	315.0		224 XL	112	569.0		388 XL	194	985.5	
126 XL	63	320.0		226 XL	113	574.0		390 XL	195	990.6	
128 XL	64	325.1		228 XL	114	579.1		392 XL	196	995.7	
130 XL	65	330.2		230 XL	115	584.2		396 XL	198	1005.8	
132 XL	66	335.3		234 XL	117	594.4		400 XL	200	1016.0	
134 XL	67	340.4		236 XL	118	599.4		408 XL	204	1036.3	
136 XL	68	345.4		240 XL	120	609.6		412 XL	206	1046.5	
138 XL	69	350.5		244 XL	122	619.8		414 XL	207	1051.6	
140 XL	70	355.6		248 XL	124	629.9		420 XL	210	1066.8	
142 XL	71	360.7		250 XL	125	635.0		424 XL	212	1077.0	
144 XL	72	365.8		254 XL	127	645.2		430 XL	215	1092.2	
146 XL	73	370.8		256 XL	128	650.2		432 XL	216	1097.3	
148 XL	74	375.9		260 XL	130	660.4		434 XL	217	1102.4	
150 XL	75	381.0		262 XL	131	665.5		438 XL	219	1112.5	
152 XL	76	386.1		266 XL	133	675.6		440 XL	220	1117.6	
154 XL	77	391.2		270 XL	135	685.8		450 XL	225	1143.0	
156 XL	78	396.2		274 XL	137	696.0		456 XL	228	1158.2	

KAUÇUK ZAMAN KAYIŞLARI

XL (1/5" 5,08 mm)								USD			
TİP TYPE	DİŞ TEETH	ÇEVRE LENGTH	1 MM	TİP TYPE	DİŞ TEETH	ÇEVRE LENGTH	1 MM	TİP TYPE	DİŞ TEETH	ÇEVRE LENGTH	1 MM
460 XL	230	1168.4		540 XL	270	1371.6		672 XL	336	1706.9	
468 XL	234	1188.7		550 XL	275	1397.0		686 XL	343	1742.4	
470 XL	235	1193.8		564 XL	282	1432.6		690 XL	345	1752.6	
480 XL	240	1219.2		572 XL	286	1452.9		700 XL	350	1778.0	
490 XL	245	1244.6		580 XL	290	1473.2		710 XL	355	1803.4	
496 XL	248	1259.8		592 XL	296	1503.7		720 XL	360	1828.8	
498 XL	249	1264.9		600 XL	300	1524.0		736 XL	368	1869.4	
500 XL	250	1270.0		608 XL	304	1544.3		828 XL	414	2103.1	
506 XL	253	1285.2		612 XL	306	1554.5		850 XL	425	2159.0	
510 XL	255	1295.4		630 XL	315	1600.2		860 XL	430	2184.4	
522 XL	261	1325.9		638 XL	319	1620.5		884 XL	442	2245.4	
530 XL	265	1346.2		670 XL	335	1701.8		1020 XL	510	2590.8	



KAUÇUK ZAMAN KAYIŞLARI

L (3/8" 9,525 mm)

USD

TİP TYPE	DİŞ TEETH	ÇEVRE LENGTH	1 MM	TİP TYPE	DİŞ TEETH	ÇEVRE LENGTH	1 MM	TİP TYPE	DİŞ TEETH	ÇEVRE LENGTH	1 MM
86 L	23	219.1		328 L	87	828.7		697 L	186	1771.7	
98 L	26	247.7		330 L	88	838.2		701 L	187	1781.2	
109 L	29	276.2		334 L	89	847.7		720 L	192	1828.8	
113 L	30	285.8		337 L	90	857.3		728 L	194	1847.9	
120 L	32	304.8		341 L	91	866.8		731 L	195	1857.4	
124 L	33	314.3		345 L	92	876.3		739 L	197	1876.4	
130 L	35	333.4		352 L	93	885.8		765 L	204	1943.1	
135 L	36	342.9		355 L	94	895.4		769 L	205	1952.6	
143 L	38	362.0		360 L	96	914.4		788 L	210	2000.3	
150 L	40	381.0		367 L	98	933.5		791 L	211	2009.8	
154 L	41	390.5		375 L	100	952.5		817 L	217	2066.9	
158 L	42	400.1		382 L	102	971.6		863 L	230	2190.7	
161 L	43	409.6		390 L	104	990.6		874 L	233	2219.3	
165 L	44	419.1		394 L	105	1000.1		900 L	240	2286.0	
169 L	45	428.6		397 L	106	1009.7		915 L	244	2324.1	
173 L	46	438.2		400 L	107	1019.2		938 L	250	2381.3	
177 L	47	447.7		405 L	108	1028.7		982 L	262	2495.6	
180 L	48	457.2		408 L	109	1038.2		994 L	265	2524.1	
185 L	49	466.7		412 L	110	1047.8		1043 L	278	2648.0	
187 L	50	476.3		420 L	112	1066.8		1148 L	306	2914.7	
191 L	51	485.8		427 L	114	1085.9		1200 L	320	3048.0	
195 L	52	495.3		435 L	116	1104.9		1275 L	340	3238.5	
198 L	53	504.8		439 L	117	1114.4					
203 L	54	514.4		442 L	118	1124.0					
206 L	55	523.9		446 L	119	1133.5					
210 L	56	533.4		450 L	120	1143.0					
217 L	58	552.5		454 L	121	1152.5					
220 L	59	562.0		457 L	122	1162.1					
225 L	60	571.5		465 L	124	1181.1					
230 L	61	581.0		480 L	128	1219.2					
232 L	62	590.6		495 L	132	1257.3					
236 L	63	600.1		510 L	136	1295.4					
240 L	64	609.6		514 L	137	1304.9					
244 L	65	619.1		525 L	140	1333.5					
248 L	66	628.7		540 L	144	1371.6					
250 L	67	638.2		548 L	146	1390.7					
255 L	68	647.7		550 L	147	1400.2					
258 L	69	657.2		560 L	149	1419.2					
263 L	70	666.8		570 L	152	1447.8					
266 L	71	676.3		581 L	155	1476.4					
270 L	72	685.8		585 L	156	1485.9					
277 L	74	704.9		600 L	160	1524.0					
280 L	75	714.4		605 L	161	1533.5					
285 L	76	723.9		619 L	165	1571.6					
300 L	80	762.0		630 L	168	1600.2					
304 L	81	771.5		640 L	170	1619.3					
310 L	83	790.6		653 L	174	1657.4					
315 L	84	800.1		660 L	176	1676.4					
319 L	85	809.6		675 L	180	1714.5					
322 L	86	819.2		694 L	185	1762.1					

KAUÇUK ZAMAN KAYIŞLARI

H (1/2" 12.7 mm)								USD			
TİP TYPE	DİŞ TEETH	ÇEVRE LENGTH	1 MM	TİP TYPE	DİŞ TEETH	ÇEVRE LENGTH	1 MM	TİP TYPE	DİŞ TEETH	ÇEVRE LENGTH	1 MM
145 H	29	368.3		540 H	108	1371.6		1140 H	228	2895.6	
185 H	37	469.9		550 H	110	1397.0		1150 H	230	2921.0	
200 H	40	508.0		560 H	112	1422.4		1200 H	240	3048.0	
210 H	42	533.4		565 H	113	1435.1		1240 H	248	3149.6	
220 H	44	558.8		570 H	114	1447.8		1250 H	250	3175.0	
225 H	45	571.5		580 H	116	1473.2		1270 H	254	3225.8	
230 H	46	584.2		590 H	118	1498.6		1285 H	257	3263.9	
240 H	48	609.6		600 H	120	1524.0		1325 H	265	3365.5	
245 H	49	622.3		605 H	121	1536.7		1350 H	270	3429.0	
250 H	50	635.0		610 H	122	1549.4		1360 H	272	3454.4	
255 H	51	647.7		615 H	123	1562.1		1400 H	280	3556.0	
260 H	52	660.4		620 H	124	1574.8		1450 H	290	3683.0	
270 H	54	685.8		625 H	125	1587.5		1460 H	292	3708.4	
280 H	56	711.2		630 H	126	1600.2		1500 H	300	3810.0	
285 H	57	723.9		640 H	128	1625.6		1550 H	310	3937.0	
290 H	58	736.6		650 H	130	1651.0		1560 H	312	3962.4	
300 H	60	762.0		660 H	132	1676.4		1600 H	320	4064.0	
310 H	62	787.4		670 H	134	1701.8		1630 H	326	4140.2	
315 H	63	800.1		680 H	136	1727.2		1680 H	336	4267.2	
320 H	64	812.8		700 H	140	1778.0		1700 H	340	4318.0	
330 H	66	838.2		710 H	142	1803.4		1800 H	360	4572.0	
335 H	67	850.9		720 H	144	1828.8		1850 H	370	4699.0	
340 H	68	863.6		725 H	145	1841.5		1900 H	380	4826.0	
345 H	69	876.3		730 H	146	1854.2		2010 H	402	5105.4	
350 H	70	889.0		740 H	148	1879.6		2050 H	410	5207.0	
360 H	72	914.4		750 H	150	1905.0		2100 H	420	5334.0	
365 H	73	927.1		760 H	152	1930.4		2200 H	440	5588.0	
370 H	74	939.8		770 H	154	1955.8		2210 H	442	5613.4	
375 H	75	952.5		780 H	156	1981.2		2360 H	472	5994.4	
380 H	76	965.2		800 H	160	2032.0		2500 H	500	6350.0	
390 H	78	990.6		810 H	162	2057.4		2600 H	520	6604.0	
395 H	79	1003.3		820 H	164	2082.8		2680 H	536	6807.2	
400 H	80	1016.0		830 H	166	2108.2		2700 H	540	6858.0	
405 H	81	1028.7		840 H	168	2133.6		2720 H	544	6908.8	
410 H	82	1041.4		850 H	170	2159.0					
420 H	84	1066.8		860 H	172	2184.4					
430 H	86	1092.2		870 H	174	2209.8					
440 H	88	1117.6		880 H	176	2235.2					
445 H	89	1130.3		900 H	180	2286.0					
450 H	90	1143.0		950 H	190	2413.0					
460 H	92	1168.4		980 H	196	2489.2					
465 H	93	1181.1		985 H	197	2501.9					
470 H	94	1193.8		1000 H	200	2540.0					
480 H	96	1219.2		1020 H	204	2590.8					
490 H	98	1244.6		1040 H	208	2641.6					
500 H	100	1270.0		1050 H	210	2667.0					
510 H	102	1295.4		1070 H	214	2717.8					
520 H	104	1320.8		1100 H	220	2794.0					
525 H	105	1333.5		1120 H	224	2844.8					
530 H	106	1346.2		1130 H	226	2870.2					

KAUÇUK ZAMAN KAYIŞLARI

XH (7/8" 22.225 mm)

USD

TİP TYPE	DİŞ TEETH	ÇEVRE LENGTH	1 MM	TİP TYPE	DİŞ TEETH	ÇEVRE LENGTH	1 MM	TİP TYPE	DİŞ TEETH	ÇEVRE LENGTH	1 MM
464 XH	53	1177.9		700 XH	80	1778.0		1000 XH	114	2533.7	
473 XH	54	1200.2		735 XH	84	1866.9		1120 XH	128	2844.8	
507 XH	58	1289.1		752 XH	86	1911.4		1260 XH	144	3200.4	
560 XH	64	1422.4		770 XH	88	1955.8		1400 XH	160	3556.0	
570 XH	65	1444.6		840 XH	96	2133.6		1540 XH	176	3911.6	
580 XH	66	1466.9		875 XH	100	2222.5		1750 XH	200	4445.0	
630 XH	72	1600.2		980 XH	112	2489.2					

XXH (5/4" 31.75 mm)

USD

TİP TYPE	DİŞ TEETH	ÇEVRE LENGTH	1 MM	TİP TYPE	DİŞ TEETH	ÇEVRE LENGTH	1 MM	TİP TYPE	DİŞ TEETH	ÇEVRE LENGTH	1 MM
625 XXH	50	1587.5		900 XXH	72	2286.0		1600 XXH	128	4064.0	
650 XXH	52	1651.0		1000 XXH	80	2540.0		1700 XXH	136	4318.0	
700 XXH	56	1778.0		1200 XXH	96	3048.0		1800 XXH	144	4572.0	
800 XXH	64	2032.0		1400 XXH	112	3556.0		1915 XXH	153	4857.8	



KAUÇUK ZAMAN KAYIŞLARI

HTD-3 M (3 MM)												USD
BELT NO KAYIŞ NO	TİP TYPE	DİŞ TEETH	1 MM	BELT NO KAYIŞ NO	TİP TYPE	DİŞ TEETH	1 MM	BELT NO KAYIŞ NO	TİP TYPE	DİŞ TEETH	1 MM	
111	3 M	37		300	3 M	100		552	3 M	184		
120	3 M	40		306	3 M	102		558	3 M	186		
123	3 M	41		309	3 M	103		564	3 M	188		
126	3 M	42		312	3 M	104		570	3 M	190		
129	3 M	43		318	3 M	106		576	3 M	192		
135	3 M	45		321	3 M	107		582	3 M	194		
141	3 M	47		324	3 M	108		588	3 M	196		
144	3 M	48		330	3 M	110		591	3 M	197		
147	3 M	49		333	3 M	111		594	3 M	198		
150	3 M	50		336	3 M	112		597	3 M	199		
156	3 M	52		339	3 M	113		600	3 M	200		
159	3 M	53		345	3 M	115		603	3 M	201		
165	3 M	55		351	3 M	117		606	3 M	202		
168	3 M	56		354	3 M	118		612	3 M	204		
171	3 M	57		357	3 M	119		633	3 M	211		
174	3 M	58		360	3 M	120		648	3 M	216		
177	3 M	59		363	3 M	121		654	3 M	218		
180	3 M	60		366	3 M	122		669	3 M	223		
183	3 M	61		369	3 M	123		672	3 M	224		
186	3 M	62		372	3 M	124		675	3 M	225		
189	3 M	63		375	3 M	125		681	3 M	227		
192	3 M	64		381	3 M	127		684	3 M	228		
195	3 M	65		384	3 M	128		687	3 M	229		
201	3 M	67		390	3 M	130		699	3 M	233		
204	3 M	68		399	3 M	133		708	3 M	236		
207	3 M	69		405	3 M	135		711	3 M	237		
210	3 M	70		411	3 M	137		741	3 M	247		
213	3 M	71		420	3 M	140		750	3 M	250		
216	3 M	72		426	3 M	142		765	3 M	255		
219	3 M	73		432	3 M	144		780	3 M	260		
225	3 M	75		438	3 M	146		801	3 M	267		
228	3 M	76		447	3 M	149		804	3 M	268		
231	3 M	77		459	3 M	153		810	3 M	270		
234	3 M	78		462	3 M	154		816	3 M	272		
237	3 M	79		474	3 M	158		825	3 M	275		
240	3 M	80		477	3 M	159		843	3 M	281		
243	3 M	81		480	3 M	160		852	3 M	284		
246	3 M	82		486	3 M	162		900	3 M	300		
249	3 M	83		492	3 M	164		930	3 M	310		
252	3 M	84		495	3 M	165		939	3 M	313		
255	3 M	85		501	3 M	167		1068	3 M	356		
264	3 M	88		513	3 M	171		1125	3 M	375		
267	3 M	89		516	3 M	172		1263	3 M	421		
270	3 M	90		519	3 M	173		1344	3 M	448		
276	3 M	92		522	3 M	174		1569	3 M	523		
282	3 M	94		525	3 M	175		1800	3 M	600		
285	3 M	95		531	3 M	177		1863	3 M	621		
288	3 M	96		534	3 M	178		2388	3 M	796		
291	3 M	97		537	3 M	179		2640	3 M	880		
294	3 M	98		540	3 M	180		3000	3 M	1000		
297	3 M	99		546	3 M	182						

KAUÇUK ZAMAN KAYIŞLARI

HTD-5 M (5 MM)

USD

BELT NO KAYIŞ NO	TİP TYPE	DIŞ TEETH	1 MM	BELT NO KAYIŞ NO	TİP TYPE	DIŞ TEETH	1 MM	BELT NO KAYIŞ NO	TİP TYPE	DIŞ TEETH	1 MM
120	5 M	24		530	5 M	106		900	5 M	180	
180	5 M	36		535	5 M	107		920	5 M	184	
200	5 M	40		540	5 M	108		925	5 M	185	
210	5 M	42		550	5 M	110		930	5 M	186	
225	5 M	45		560	5 M	112		935	5 M	187	
230	5 M	46		565	5 M	113		940	5 M	188	
235	5 M	47		570	5 M	114		950	5 M	190	
245	5 M	49		575	5 M	115		955	5 M	191	
250	5 M	50		580	5 M	116		960	5 M	192	
255	5 M	51		585	5 M	117		965	5 M	193	
260	5 M	52		590	5 M	118		975	5 M	195	
265	5 M	53		600	5 M	120		980	5 M	196	
270	5 M	54		610	5 M	122		985	5 M	197	
275	5 M	55		615	5 M	123		1000	5 M	200	
280	5 M	56		620	5 M	124		1025	5 M	205	
285	5 M	57		625	5 M	125		1035	5 M	207	
295	5 M	59		630	5 M	126		1050	5 M	210	
300	5 M	60		635	5 M	127		1080	5 M	216	
305	5 M	61		640	5 M	128		1100	5 M	220	
310	5 M	62		645	5 M	129		1125	5 M	225	
320	5 M	64		650	5 M	130		1135	5 M	227	
325	5 M	65		655	5 M	131		1145	5 M	229	
330	5 M	66		665	5 M	133		1150	5 M	230	
335	5 M	67		670	5 M	134		1175	5 M	235	
340	5 M	68		675	5 M	135		1180	5 M	236	
345	5 M	69		680	5 M	136		1200	5 M	240	
350	5 M	70		690	5 M	138		1210	5 M	243	
360	5 M	72		695	5 M	139		1225	5 M	245	
365	5 M	73		700	5 M	140		1250	5 M	250	
370	5 M	74		710	5 M	142		1270	5 M	254	
375	5 M	75		720	5 M	144		1295	5 M	259	
385	5 M	77		730	5 M	146		1350	5 M	270	
390	5 M	78		740	5 M	148		1400	5 M	280	
400	5 M	80		745	5 M	149		1420	5 M	284	
405	5 M	81		750	5 M	150		1500	5 M	300	
410	5 M	82		755	5 M	151		1595	5 M	319	
420	5 M	84		770	5 M	154		1690	5 M	338	
425	5 M	85		775	5 M	155		1700	5 M	350	
435	5 M	87		780	5 M	156		1800	5 M	360	
440	5 M	88		790	5 M	158		1870	5 M	374	
450	5 M	90		800	5 M	160		1895	5 M	379	
460	5 M	92		810	5 M	162		1945	5 M	389	
465	5 M	93		815	5 M	163		2000	5 M	400	
470	5 M	94		825	5 M	165		2060	5 M	412	
475	5 M	95		830	5 M	166		2100	5 M	420	
480	5 M	96		835	5 M	167		2250	5 M	450	
490	5 M	98		845	5 M	169		2350	5 M	470	
500	5 M	100		850	5 M	170		2500	5 M	500	
510	5 M	102		860	5 M	172		2525	5 M	505	
520	5 M	104		870	5 M	174		2650	5 M	530	
525	5 M	105		890	5 M	178		3770	5 M	754	
								4260	5 M	852	

KAUÇUK ZAMAN KAYIŞLARI

HTD-8 M (8 MM)								USD			
BELT NO KAYIŞ NO	TİP TYPE	DİŞ TEETH	1 MM	BELT NO KAYIŞ NO	TİP TYPE	DİŞ TEETH	1 MM	BELT NO KAYIŞ NO	TİP TYPE	DİŞ TEETH	1 MM
288	8 M	36		984	8 M	123		1800	8 M	225	
320	8 M	40		1000	8 M	125		1840	8 M	230	
376	8 M	47		1016	8 M	128		1880	8 M	235	
384	8 M	48		1032	8 M	129		1904	8 M	238	
400	8 M	50		1040	8 M	130		1936	8 M	242	
408	8 M	51		1056	8 M	132		1960	8 M	245	
416	8 M	52		1064	8 M	133		2000	8 M	250	
424	8 M	53		1080	8 M	135		2032	8 M	254	
480	8 M	60		1096	8 M	137		2080	8 M	260	
496	8 M	61		1120	8 M	140		2104	8 M	263	
512	8 M	64		1128	8 M	141		2160	8 M	270	
520	8 M	65		1136	8 M	142		2200	8 M	275	
536	8 M	67		1152	8 M	144		2208	8 M	276	
544	8 M	68		1160	8 M	145		2240	8 M	280	
560	8 M	70		1176	8 M	147		2248	8 M	281	
576	8 M	72		1184	8 M	148		2272	8 M	284	
584	8 M	73		1200	8 M	150		2304	8 M	288	
592	8 M	74		1216	8 M	152		2400	8 M	300	
600	8 M	75		1224	8 M	153		2488	8 M	311	
608	8 M	76		1240	8 M	155		2504	8 M	313	
624	8 M	78		1256	8 M	157		2600	8 M	325	
632	8 M	79		1264	8 M	158		2656	8 M	332	
640	8 M	80		1280	8 M	160		2800	8 M	350	
656	8 M	82		1296	8 M	162		2840	8 M	355	
672	8 M	84		1304	8 M	163		2848	8 M	356	
680	8 M	85		1312	8 M	164		3048	8 M	381	
696	8 M	87		1320	8 M	165		3120	8 M	390	
712	8 M	89		1328	8 M	166		3200	8 M	400	
720	8 M	90		1344	8 M	168		3280	8 M	410	
728	8 M	91		1360	8 M	170		3360	8 M	420	
760	8 M	95		1392	8 M	174		3400	8 M	425	
776	8 M	97		1400	8 M	175		3424	8 M	428	
784	8 M	98		1424	8 M	178		3600	8 M	450	
800	8 M	100		1432	8 M	179		4000	8 M	500	
824	8 M	103		1440	8 M	180		4224	8 M	528	
832	8 M	104		1480	8 M	185		4400	8 M	550	
840	8 M	105		1512	8 M	189		4520	8 M	565	
848	8 M	106		1520	8 M	190		5120	8 M	640	
856	8 M	107		1552	8 M	194		5600	8 M	700	
872	8 M	109		1560	8 M	195		5960	8 M	745	
880	8 M	110		1600	8 M	200		6600	8 M	825	
896	8 M	112		1624	8 M	203		6880	8 M	860	
912	8 M	114		1640	8 M	205					
920	8 M	115		1656	8 M	207					
936	8 M	117		1680	8 M	210					
944	8 M	118		1696	8 M	212					
952	8 M	119		1720	8 M	215					
960	8 M	120		1728	8 M	216					
968	8 M	121		1760	8 M	220					
976	8 M	122		1776	8 M	222					

KAUÇUK ZAMAN KAYIŞLARI

HTD-14 M (14 MM)

USD

BELT NO KAYIŞ NO	TİP TYPE	DİŞ TEETH	1 MM	BELT NO KAYIŞ NO	TİP TYPE	DİŞ TEETH	1 MM	BELT NO KAYIŞ NO	TİP TYPE	DİŞ TEETH	1 MM
784	14 M	56		1680	14 M	120		2590	14 M	185	
924	14 M	66		1736	14 M	124		2660	14 M	190	
938	14 M	67		1750	14 M	125		2688	14 M	192	
966	14 M	69		1764	14 M	126		2730	14 M	195	
1036	14 M	74		1778	14 M	127		2758	14 M	197	
1050	14 M	75		1792	14 M	128		2800	14 M	200	
1064	14 M	76		1820	14 M	130		2898	14 M	207	
1092	14 M	78		1890	14 M	135		2940	14 M	210	
1120	14 M	80		1904	14 M	136		3038	14 M	217	
1190	14 M	85		1946	14 M	139		3150	14 M	225	
1246	14 M	89		1960	14 M	140		3360	14 M	240	
1260	14 M	90		1988	14 M	142		3500	14 M	250	
1288	14 M	92		2002	14 M	143		3850	14 M	275	
1344	14 M	96		2044	14 M	146		4004	14 M	286	
1400	14 M	100		2100	14 M	150		4326	14 M	309	
1442	14 M	103		2156	14 M	154		4536	14 M	324	
1456	14 M	104		2198	14 M	157		4578	14 M	327	
1512	14 M	108		2240	14 M	160		4760	14 M	340	
1540	14 M	110		2310	14 M	165		4956	14 M	354	
1568	14 M	112		2338	14 M	167		5012	14 M	358	
1610	14 M	115		2380	14 M	170		5320	14 M	380	
1638	14 M	117		2450	14 M	175		5740	14 M	410	
1652	14 M	118		2520	14 M	180		6160	14 M	440	
								6860	14 M	490	

HTD-20 M (20 MM) USD

BELT NO KAYIŞ NO	TİP TYPE	DİŞ TEETH	1 MM
2000	20 M	100	
2140	20 M	107	
2400	20 M	120	
2500	20 M	125	
2600	20 M	130	
3200	20 M	160	
3220	20 M	161	
3400	20 M	170	
3800	20 M	190	
4200	20 M	210	
4600	20 M	230	
5000	20 M	250	
5200	20 M	260	
5400	20 M	270	
5500	20 M	275	
6000	20 M	300	
6560	20 M	328	

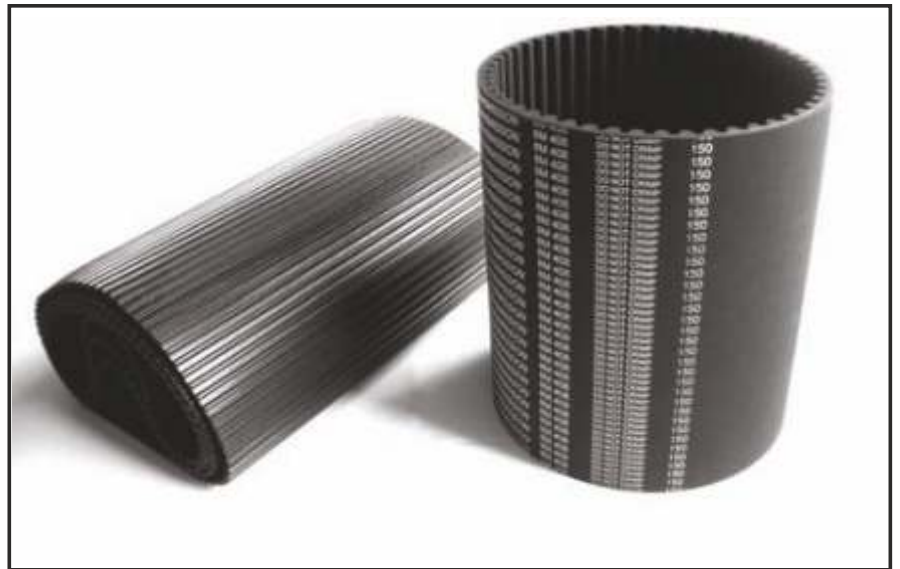

KAUÇUK ZAMAN KAYIŞLARI

STD-2 M (2 MM)

USD

BELT NO KAYIŞ NO	TİP TYPE	DİŞ TEETH	1 MM	BELT NO KAYIŞ NO	TİP TYPE	DİŞ TEETH	1 MM	BELT NO KAYIŞ NO	TİP TYPE	DİŞ TEETH	1 MM
88	S2M	44	***	274	S2M	137	***	572	S2M	286	***
90	S2M	45	***	280	S2M	140	***	594	S2M	297	***
92	S2M	46	***	284	S2M	142	***	596	S2M	298	***
94	S2M	47	***	286	S2M	143	***	600	S2M	300	***
98	S2M	48	***	288	S2M	144	***	604	S2M	302	***
102	S2M	51	***	290	S2M	145	***	620	S2M	310	***
104	S2M	52	***	292	S2M	146	***	630	S2M	315	***
106	S2M	53	***	296	S2M	148	***	652	S2M	326	***
112	S2M	56	***	300	S2M	150	***	656	S2M	328	***
114	S2M	57	***	302	S2M	151	***	660	S2M	330	***
116	S2M	58	***	304	S2M	152	***	668	S2M	334	***
118	S2M	59	***	306	S2M	153	***	676	S2M	338	***
120	S2M	60	***	308	S2M	154	***	692	S2M	346	***
124	S2M	62	***	310	S2M	155	***	700	S2M	350	***
128	S2M	64	***	312	S2M	156	***	710	S2M	355	***
130	S2M	65	***	316	S2M	158	***	726	S2M	363	***
132	S2M	66	***	318	S2M	159	***	742	S2M	371	***
134	S2M	67	***	320	S2M	160	***	752	S2M	376	***
138	S2M	69	***	322	S2M	161	***	754	S2M	377	***
140	S2M	70	***	324	S2M	162	***	760	S2M	380	***
144	S2M	72	***	328	S2M	164	***	766	S2M	383	***
146	S2M	73	***	330	S2M	165	***	796	S2M	398	***
150	S2M	75	***	332	S2M	166	***	800	S2M	400	***
152	S2M	76	***	334	S2M	167	***	810	S2M	405	***
156	S2M	78	***	340	S2M	170	***	860	S2M	430	***
160	S2M	80	***	342	S2M	171	***	880	S2M	440	***
164	S2M	82	***	350	S2M	175	***	892	S2M	446	***
172	S2M	86	***	356	S2M	178	***	896	S2M	448	***
182	S2M	91	***	360	S2M	180	***	898	S2M	449	***
186	S2M	93	***	364	S2M	182	***	900	S2M	450	***
190	S2M	95	***	370	S2M	185	***	940	S2M	470	***
192	S2M	96	***	376	S2M	188	***	984	S2M	492	***
194	S2M	97	***	380	S2M	190	***	1000	S2M	500	***
200	S2M	100	***	386	S2M	193	***	1032	S2M	516	***
202	S2M	101	***	390	S2M	195	***	1036	S2M	518	***
204	S2M	102	***	392	S2M	196	***	1066	S2M	533	***
210	S2M	105	***	400	S2M	200	***	1074	S2M	537	***
212	S2M	106	***	406	S2M	203	***	1100	S2M	550	***
218	S2M	109	***	420	S2M	210	***	1110	S2M	555	***
230	S2M	115	***	436	S2M	218	***	1136	S2M	568	***
236	S2M	118	***	440	S2M	220	***	1154	S2M	577	***
240	S2M	120	***	452	S2M	226	***	1166	S2M	583	***
244	S2M	122	***	460	S2M	230	***	1224	S2M	612	***
250	S2M	125	***	468	S2M	234	***	1228	S2M	614	***
252	S2M	126	***	492	S2M	246	***	3000	S2M	1500	***
256	S2M	128	***	500	S2M	250	***	3672	S2M	1836	***
260	S2M	130	***	506	S2M	253	***	3828	S2M	1914	***
264	S2M	132	***	520	S2M	260	***				
266	S2M	133	***	560	S2M	280	***				

KAUÇUK ZAMAN KAYIŞLARI

STD-3 M (3 MM)

USD

BELT NO KAYIŞ NO	TİP TYPE	DİŞ TEETH	1 MM	BELT NO KAYIŞ NO	TİP TYPE	DİŞ TEETH	1 MM	BELT NO KAYIŞ NO	TİP TYPE	DİŞ TEETH	1 MM
150	S 3M	50		330	S 3M	110		507	S 3M	169	
174	S 3M	58		339	S 3M	113		510	S 3M	170	
177	S 3M	59		354	S 3M	118		537	S 3M	179	
192	S 3M	64		357	S 3M	119		564	S 3M	188	
201	S 3M	67		384	S 3M	128		600	S 3M	200	
207	S 3M	69		390	S 3M	130		633	S 3M	211	
210	S 3M	70		402	S 3M	134		660	S 3M	220	
231	S 3M	77		408	S 3M	136		741	S 3M	247	
246	S 3M	82		465	S 3M	155		900	S 3M	300	
276	S 3M	92		486	S 3M	162		1188	S 3M	396	
324	S 3M	108		501	S 3M	167					

STD-4,5 M (4,5 MM)

USD

BELT NO KAYIŞ NO	TİP TYPE	DİŞ TEETH	1 MM	BELT NO KAYIŞ NO	TİP TYPE	DİŞ TEETH	1 MM	BELT NO KAYIŞ NO	TİP TYPE	DİŞ TEETH	1 MM
180	S 4,5M	40		338	S 4,5M	75		549	S 4,5M	122	
198	S 4,5M	44		347	S 4,5M	77		558	S 4,5M	124	
212	S 4,5M	47		351	S 4,5M	78		563	S 4,5M	125	
216	S 4,5M	48		360	S 4,5M	80		612	S 4,5M	136	
225	S 4,5M	50		369	S 4,5M	82		630	S 4,5M	140	
234	S 4,5M	52		383	S 4,5M	85		653	S 4,5M	145	
239	S 4,5M	53		396	S 4,5M	88		711	S 4,5M	158	
252	S 4,5M	56		414	S 4,5M	92		720	S 4,5M	160	
275	S 4,5M	61		437	S 4,5M	97		729	S 4,5M	162	
279	S 4,5M	62		441	S 4,5M	98		801	S 4,5M	178	
284	S 4,5M	63		450	S 4,5M	100		864	S 4,5M	192	
297	S 4,5M	66		486	S 4,5M	108		905	S 4,5M	201	
306	S 4,5M	68		491	S 4,5M	109		932	S 4,5M	207	
315	S 4,5M	70		500	S 4,5M	111		1031	S 4,5M	229	
324	S 4,5M	72		504	S 4,5M	112		2111	S 4,5M	469	
333	S 4,5M	74		518	S 4,5M	115					

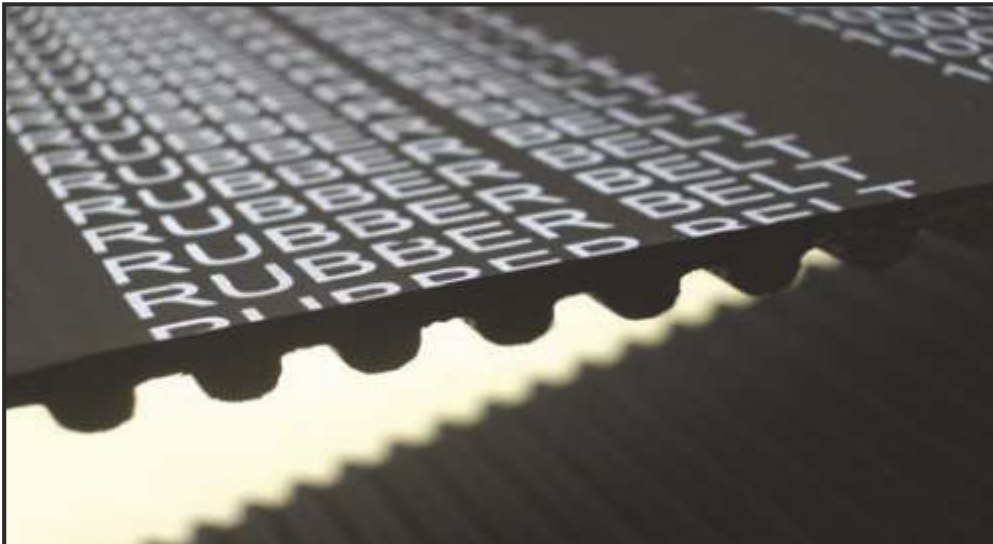

KAUÇUK ZAMAN KAYIŞLARI

STD-5 M (5 MM)								USD			
BELT NO KAYIŞ NO	TİP TYPE	DİŞ TEETH	1 MM	BELT NO KAYIŞ NO	TİP TYPE	DİŞ TEETH	1 MM	BELT NO KAYIŞ NO	TİP TYPE	DİŞ TEETH	1 MM
180	S 5M	36		625	S 5M	125		1025	S 5M	205	
250	S 5M	50		635	S 5M	127		1050	S 5M	210	
255	S 5M	51		645	S 5M	129		1125	S 5M	225	
275	S 5M	55		650	S 5M	130		1145	S 5M	229	
280	S 5M	56		665	S 5M	133		1200	S 5M	240	
295	S 5M	59		670	S 5M	134		1225	S 5M	245	
300	S 5M	60		675	S 5M	135		1250	S 5M	250	
340	S 5M	68		690	S 5M	138		1270	S 5M	254	
350	S 5M	70		700	S 5M	140		1350	S 5M	270	
355	S 5M	71		710	S 5M	142		1420	S 5M	284	
375	S 5M	75		750	S 5M	150		1500	S 5M	300	
390	S 5M	78		800	S 5M	160		1550	S 5M	310	
400	S 5M	80		810	S 5M	162		1595	S 5M	319	
415	S 5M	83		830	S 5M	166		1615	S 5M	323	
420	S 5M	84		835	S 5M	167		1690	S 5M	338	
425	S 5M	85		850	S 5M	170		1800	S 5M	360	
450	S 5M	90		860	S 5M	172		1945	S 5M	389	
475	S 5M	95		865	S 5M	173		1960	S 5M	392	
490	S 5M	98		890	S 5M	178		2000	S 5M	400	
500	S 5M	100		900	S 5M	180		2100	S 5M	420	
520	S 5M	104		940	S 5M	188		2525	S 5M	505	
550	S 5M	110		950	S 5M	190		2800	S 5M	560	
560	S 5M	112		960	S 5M	192		3280	S 5M	656	
575	S 5M	115		975	S 5M	195					
600	S 5M	120		1000	S 5M	200					

STD-8 M (8 MM)								USD			
BELT NO KAYIŞ NO	TİP TYPE	DİŞ TEETH	1 MM	BELT NO KAYIŞ NO	TİP TYPE	DİŞ TEETH	1 MM	BELT NO KAYIŞ NO	TİP TYPE	DİŞ TEETH	1 MM
424	S 8M	53		776	S 8M	97		1072	S 8M	134	
432	S 8M	54		792	S 8M	99		1096	S 8M	137	
480	S 8M	60		800	S 8M	100		1120	S 8M	140	
496	S 8M	62		824	S 8M	103		1128	S 8M	141	
520	S 8M	65		840	S 8M	105		1136	S 8M	142	
560	S 8M	70		848	S 8M	106		1152	S 8M	144	
584	S 8M	73		880	S 8M	110		1160	S 8M	145	
592	S 8M	74		888	S 8M	111		1184	S 8M	148	
600	S 8M	75		896	S 8M	112		1192	S 8M	149	
632	S 8M	79		920	S 8M	115		1200	S 8M	150	
640	S 8M	80		944	S 8M	118		1216	S 8M	152	
656	S 8M	82		960	S 8M	120		1224	S 8M	153	
672	S 8M	84		976	S 8M	122		1240	S 8M	155	
680	S 8M	85		984	S 8M	123		1248	S 8M	156	
704	S 8M	88		1000	S 8M	125		1256	S 8M	157	
712	S 8M	89		1016	S 8M	127		1264	S 8M	158	
720	S 8M	90		1024	S 8M	128		1280	S 8M	160	
728	S 8M	91		1032	S 8M	129		1304	S 8M	163	
752	S 8M	94		1040	S 8M	130		1320	S 8M	165	
760	S 8M	95		1056	S 8M	132		1344	S 8M	168	

KAUÇUK ZAMAN KAYIŞLARI

STD/STS 8 M (8 MM)

USD

BELT NO KAYIŞ NO	TİP TYPE	DİŞ TEETH	1 MM	BELT NO KAYIŞ NO	TİP TYPE	DİŞ TEETH	1 MM	BELT NO KAYIŞ NO	TİP TYPE	DİŞ TEETH	1 MM
1352	S 8M	169		1760	S 8M	220	0,680	2800	S 8M	350	
1360	S 8M	170		1792	S 8M	224	0,738	2848	S 8M	356	
1384	S 8M	173		1800	S 8M	225	0,740	3200	S 8M	400	
1400	S 8M	175		1880	S 8M	235	0,745	3280	S 8M	410	
1424	S 8M	178		1904	S 8M	238	0,746	3400	S 8M	425	
1440	S 8M	180		2000	S 8M	250	0,747	3440	S 8M	430	
1480	S 8M	185		2032	S 8M	254	0,800	3600	S 8M	450	
1512	S 8M	189		2048	S 8M	256	0,850	4000	S 8M	500	
1552	S 8M	194		2056	S 8M	257	0,823	4680	S 8M	585	
1600	S 8M	200		2120	S 8M	265	0,850	4936	S 8M	617	
1624	S 8M	203		2160	S 8M	270	0,875	5080	S 8M	635	
1632	S 8M	204		2240	S 8M	280	0,880	5600	S 8M	700	
1648	S 8M	205		2272	S 8M	284	0,884	5696	S 8M	712	
1680	S 8M	210		2400	S 8M	300	0,889	6640	S 8M	830	
1696	S 8M	212		2496	S 8M	312	0,945				
1728	S 8M	216		2600	S 8M	325	0,912				

STD/STS 14 M (14 MM)

USD

BELT NO KAYIŞ NO	TİP TYPE	DİŞ TEETH	1 MM	BELT NO KAYIŞ NO	TİP TYPE	DİŞ TEETH	1 MM	BELT NO KAYIŞ NO	TİP TYPE	DİŞ TEETH	1 MM
966	S 14M	69		1750	S 14M	125	***	2450	S 14M	175	
1008	S 14M	72		1764	S 14M	126	1,261	2590	S 14M	185	
1120	S 14M	80		1778	S 14M	127	1,262	2800	S 14M	200	
1190	S 14M	85		1806	S 14M	129	1,327	3136	S 14M	224	
1246	S 14M	89		1890	S 14M	135	1,352	3150	S 14M	225	
1344	S 14M	96		1904	S 14M	136	1,352	3500	S 14M	250	
1400	S 14M	100		1932	S 14M	138	***	3850	S 14M	275	
1456	S 14M	104		2002	S 14M	143	1,369	4004	S 14M	286	
1470	S 14M	105		2100	S 14M	150	1,377	4326	S 14M	309	
1540	S 14M	110		2240	S 14M	160	1,673	4410	S 14M	315	
1610	S 14M	115		2310	S 14M	165	1,651	4508	S 14M	322	
1652	S 14M	118		2380	S 14M	170	1,763	5012	S 14M	358	

RPP-2 M (2 MM)

RPP-3 M (3 MM)

USD

BELT NO KAYIŞ NO	TİP TYPE	DİŞ TEETH	1 MM	BELT NO KAYIŞ NO	TİP TYPE	DİŞ TEETH	1 MM	BELT NO KAYIŞ NO	TİP TYPE	DİŞ TEETH	1 MM
112	R 2M	56		174	R 3M	58		345	R 3M	115	
132	R 2M	66		177	R 3M	59		354	R 3M	118	
200	R 2M	100		180	R 3M	60		360	R 3M	120	
210	R 2M	105		201	R 3M	67		375	R 3M	125	
236	R 2M	118		210	R 3M	70		405	R 3M	135	
364	R 2M	182		225	R 3M	75		420	R 3M	140	
448	R 2M	224		240	R 3M	80		447	R 3M	149	
530	R 2M	265		255	R 3M	85		459	R 3M	153	
				264	R 3M	88		474	R 3M	158	
				267	R 3M	89		486	R 3M	162	
				270	R 3M	90		489	R 3M	163	
				279	R 3M	93		522	R 3M	174	
				312	R 3M	104		531	R 3M	177	

KAUÇUK ZAMAN KAYIŞLARI

RPP-5 M (5 MM)

USD

BELT NO KAYIŞ NO	TİP TYPE	DİŞ TEETH	1 MM	BELT NO KAYIŞ NO	TİP TYPE	DİŞ TEETH	1 MM	BELT NO KAYIŞ NO	TİP TYPE	DİŞ TEETH	1 MM
180	R 5M	36		525	R 5M	105		1125	R 5M	225	
225	R 5M	45		550	R 5M	110		1195	R 5M	239	
265	R 5M	53		565	R 5M	113		1240	R 5M	248	
295	R 5M	59		575	R 5M	115		1270	R 5M	254	
300	R 5M	60		600	R 5M	120		1420	R 5M	284	
325	R 5M	65		635	R 5M	127		1595	R 5M	319	
345	R 5M	69		670	R 5M	134		2000	R 5M	400	
360	R 5M	72		710	R 5M	142		2250	R 5M	450	
370	R 5M	74		740	R 5M	148		2525	R 5M	505	
400	R 5M	80		780	R 5M	156		3500	R 5M	700	
420	R 5M	84		800	R 5M	160					
450	R 5M	90		850	R 5M	170					
475	R 5M	95		960	R 5M	192					
500	R 5M	100		1000	R 5M	200					
510	R 5M	102		1050	R 5M	210					

RPP-8 M (8 MM)

USD

BELT NO KAYIŞ NO	TİP TYPE	DİŞ TEETH	1 MM	BELT NO KAYIŞ NO	TİP TYPE	DİŞ TEETH	1 MM	BELT NO KAYIŞ NO	TİP TYPE	DİŞ TEETH	1 MM
376	R 8M	47		896	R 8M	112		1800	R 8M	225	
480	R 8M	60		920	R 8M	115		1904	R 8M	238	
512	R 8M	64		960	R 8M	120		2032	R 8M	254	
536	R 8M	67		1000	R 8M	125		2064	R 8M	258	
560	R 8M	70		1040	R 8M	130		2104	R 8M	263	
600	R 8M	75		1096	R 8M	137		2200	R 8M	275	
632	R 8M	79		1120	R 8M	140		2320	R 8M	290	
640	R 8M	80		1200	R 8M	150		2400	R 8M	300	
680	R 8M	85		1224	R 8M	153		2600	R 8M	325	
720	R 8M	90		1280	R 8M	160		2800	R 8M	350	
760	R 8M	95		1352	R 8M	169		3048	R 8M	381	
800	R 8M	100		1440	R 8M	180		3200	R 8M	400	
840	R 8M	105		1464	R 8M	183		3304	R 8M	413	
856	R 8M	107		1600	R 8M	200		3600	R 8M	450	
880	R 8M	110									

RPP-14 M (14 MM)

USD

BELT NO KAYIŞ NO	TİP TYPE	DİŞ TEETH	1 MM	BELT NO KAYIŞ NO	TİP TYPE	DİŞ TEETH	1 MM	BELT NO KAYIŞ NO	TİP TYPE	DİŞ TEETH	1 MM
966	R 14M	85		1652	R 14M	118		2450	R 14M	175	
1064	R 14M	89		1764	R 14M	126		2800	R 14M	200	
1288	R 14M	92		1778	R 14M	127		3150	R 14M	225	
1400	R 14M	100		2100	R 14M	150		3360	R 14M	240	
1610	R 14M	115		2310	R 14M	165		4326	R 14M	309	

ÇİFT TARAFLI ZAMAN KAYIŞLARI

DXL 5,08 MM

USD

TİP TYPE	DİŞ TEETH	ÇEVRE LENGTH	1 MM	TİP TYPE	DİŞ TEETH	ÇEVRE LENGTH	1 MM	TİP TYPE	DİŞ TEETH	ÇEVRE LENGTH	1 MM
120 DXL	60	304.8		290 DXL	145	736.6		388 DXL	194	985.5	
140 DXL	70	355.6		300 DXL	150	762.0		390 DXL	195	990.6	
150 DXL	75	381.0		310 DXL	155	787.4		396 DXL	198	1005.8	
160 DXL	80	406.4		314 DXL	157	797.6		400 DXL	200	1016.0	
180 DXL	90	457.2		316 DXL	158	802.6		408 DXL	204	1036.3	
190 DXL	95	482.6		320 DXL	160	812.8		420 DXL	210	1066.8	
200 DXL	100	508.0		322 DXL	161	817.9		424 DXL	212	1077.0	
210 DXL	105	533.4		330 DXL	165	838.2		430 DXL	215	1092.2	
220 DXL	110	558.8		340 DXL	170	863.6		450 DXL	225	1143.0	
230 DXL	115	584.2		344 DXL	172	873.8		456 DXL	228	1158.2	
240 DXL	120	609.6		348 DXL	174	883.9		460 DXL	230	1168.4	
244 DXL	122	619.8		352 DXL	176	894.1		470 DXL	235	1193.8	
248 DXL	124	629.9		356 DXL	178	904.2		490 DXL	245	1244.6	
250 DXL	125	635.0		360 DXL	180	914.4		496 DXL	248	1259.8	
260 DXL	130	660.4		364 DXL	182	924.6		510 DXL	255	1295.4	
262 DXL	131	665.5		370 DXL	185	939.8		540 DXL	270	1371.6	
266 DXL	133	675.6		372 DXL	186	944.9		564 DXL	282	1432.6	
270 DXL	135	685.8		376 DXL	188	955.0		592 DXL	296	1503.7	
276 DXL	138	701.0		380 DXL	190	965.2		608 DXL	304	1544.3	
280 DXL	140	711.2		384 DXL	192	975.4		630 DXL	315	1600.2	
282 DXL	141	716.3									

DL 9,525 MM

USD

TİP TYPE	DİŞ TEETH	ÇEVRE LENGTH	1 MM	TİP TYPE	DİŞ TEETH	ÇEVRE LENGTH	1 MM	TİP TYPE	DİŞ TEETH	ÇEVRE LENGTH	1 MM
165 DL	44	419.1		277 DL	73	695.3		390 DL	104	990.6	
169 DL	45	428.6		285 DL	76	723.9		420 DL	112	1066.8	
173 DL	46	438.2		300 DL	80	762.0		450 DL	120	1143.0	
187 DL	49	466.7		319 DL	85	809.6		465 DL	124	1181.1	
203 DL	54	514.4		322 DL	85	809.6		480 DL	128	1219.2	
210 DL	56	533.4		334 DL	89	847.7		510 DL	136	1295.4	
218 DL	58	552.5		345 DL	92	876.3		540 DL	144	1371.6	
225 DL	60	571.5		360 DL	96	914.4		600 DL	160	1524.0	
240 DL	64	609.6		367 DL	97	923.9		630 DL	168	1600.2	
255 DL	68	647.7		375 DL	100	952.5		640 DL	170	1619.3	
270 DL	72	685.8		382 DL	101	962.0		660 DL	176	1676.4	

ÇİFT TARAFLI ZAMAN KAYIŞLARI

DH 12,7 MM								USD			
TİP TYPE	DİŞ TEETH	ÇEVRE LENGTH	1 MM	TİP TYPE	DİŞ TEETH	ÇEVRE LENGTH	1 MM	TİP TYPE	DİŞ TEETH	ÇEVRE LENGTH	1 MM
230 DH	46	584.2		480 DH	96	1219.2		840 DH	168	2133.6	
240 DH	48	609.6		490 DH	98	1244.6		850 DH	170	2159.0	
270 DH	54	685.8		510 DH	102	1295.4		880 DH	176	2235.2	
280 DH	56	711.2		540 DH	108	1371.6		900 DH	180	2286.0	
300 DH	60	762.0		560 DH	112	1422.4		950 DH	190	2413.0	
310 DH	62	787.4		565 DH	113	1435.1		1000 DH	200	2540.0	
320 DH	64	812.8		570 DH	114	1447.8		1020 DH	204	2590.8	
330 DH	66	838.2		580 DH	116	1473.2		1050 DH	210	2667.0	
340 DH	68	863.6		600 DH	120	1524.0		1100 DH	220	2794.0	
350 DH	70	889.0		630 DH	126	1600.2		1140 DH	228	2895.6	
360 DH	72	914.4		650 DH	130	1651.0		1150 DH	230	2921.0	
370 DH	74	939.8		660 DH	132	1676.4		1250 DH	250	3175.0	
375 DH	75	952.5		700 DH	140	1778.0		1325 DH	265	3365.5	
380 DH	76	965.2		730 DH	146	1854.2		1350 DH	270	3429.0	
390 DH	78	990.6		750 DH	150	1905.0		1400 DH	280	3556.0	
400 DH	80	1016.0		800 DH	160	2032.0		1450 DH	290	3683.0	
410 DH	82	1041.4		810 DH	162	2057.4		1600 DH	320	4064.0	
420 DH	84	1066.8		820 DH	164	2082.8		1700 DH	340	4318.0	
450 DH	90	1143.0									

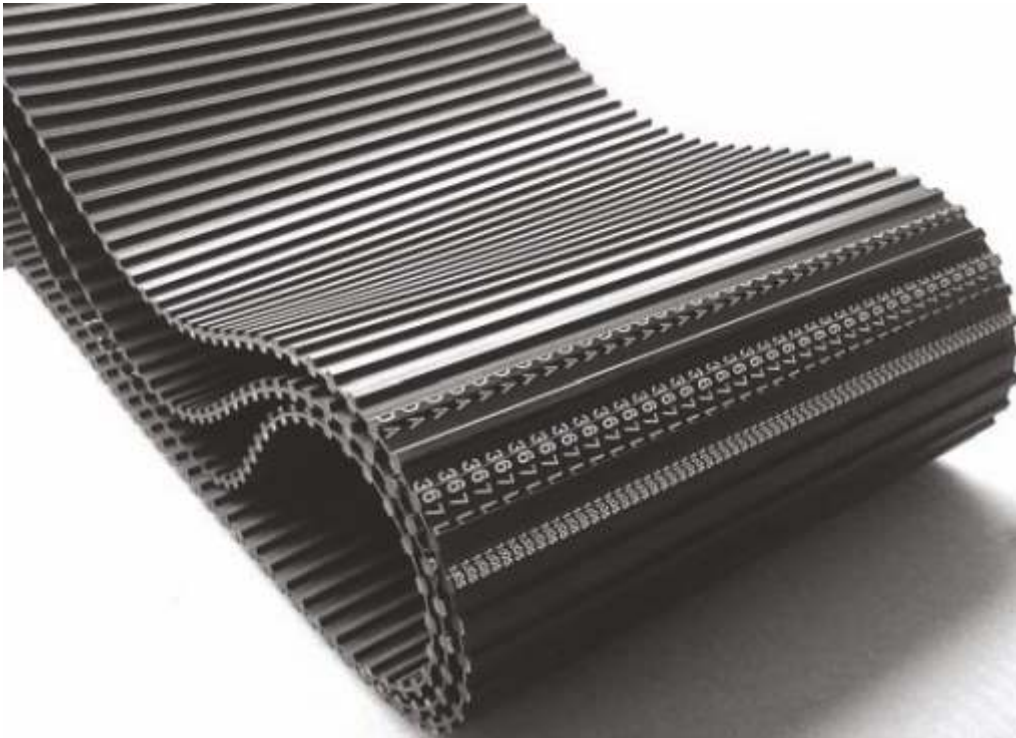

ÇİFT TARAFLI ZAMAN KAYIŞLARI

DHTD 5M (5 MM)												USD
BELT NO KAYIŞ NO	TİP TYPE	DİŞ TEETH	1 MM	BELT NO KAYIŞ NO	TİP TYPE	DİŞ TEETH	1 MM	BELT NO KAYIŞ NO	TİP TYPE	DİŞ TEETH	1 MM	
525	D 5M	105		755	D 5M	151		1050	D 5M	210		
565	D 5M	113		780	D 5M	156		1100	D 5M	220		
600	D 5M	120		800	D 5M	160		1200	D 5M	240		
615	D 5M	123		835	D 5M	167		1350	D 5M	270		
620	D 5M	124		890	D 5M	178		1420	D 5M	284		
630	D 5M	126		900	D 5M	180		1595	D 5M	319		
635	D 5M	127		925	D 5M	185		1690	D 5M	338		
665	D 5M	133		935	D 5M	187		1945	D 5M	389		
700	D 5M	140		980	D 5M	196		2000	D 5M	400		
710	D 5M	142		1000	D 5M	200		2250	D 5M	450		
740	D 5M	148										

DSTD 5M (5 MM)												USD
BELT NO KAYIŞ NO	TİP TYPE	DİŞ TEETH	1 MM	BELT NO KAYIŞ NO	TİP TYPE	DİŞ TEETH	1 MM	BELT NO KAYIŞ NO	TİP TYPE	DİŞ TEETH	1 MM	
435	DS 5M	87		800	DS 5M	160		1050	DS 5M	210		
525	DS 5M	105		825	DS 5M	165		1125	DS 5M	225		
560	DS 5M	112		835	DS 5M	167		1145	DS 5M	229		
575	DS 5M	115		840	DS 5M	168		1250	DS 5M	250		
600	DS 5M	120		850	DS 5M	170		1270	DS 5M	254		
615	DS 5M	123		900	DS 5M	180		1350	DS 5M	270		
645	DS 5M	129		950	DS 5M	190		1595	DS 5M	319		
665	DS 5M	133		960	DS 5M	192		1690	DS 5M	338		
710	DS 5M	142		1000	DS 5M	200		1800	DS 5M	360		
780	DS 5M	156										

DHTD 8M (8MM)												USD
BELT NO KAYIŞ NO	TİP TYPE	DİŞ TEETH	1 MM	BELT NO KAYIŞ NO	TİP TYPE	DİŞ TEETH	1 MM	BELT NO KAYIŞ NO	TİP TYPE	DİŞ TEETH	1 MM	
600	D 8M	75		1152	D 8M	144		1800	D 8M	225		
624	D 8M	78		1184	D 8M	148		2000	D 8M	250		
640	D 8M	80		1200	D 8M	150		2240	D 8M	280		
720	D 8M	90		1280	D 8M	160		2272	D 8M	284		
800	D 8M	100		1304	D 8M	163		2304	D 8M	288		
880	D 8M	110		1328	D 8M	166		2400	D 8M	300		
912	D 8M	114		1360	D 8M	170		2600	D 8M	325		
920	D 8M	115		1400	D 8M	175		2800	D 8M	350		
944	D 8M	118		1440	D 8M	180		3048	D 8M	381		
960	D 8M	120		1600	D 8M	200		3200	D 8M	400		
1000	D 8M	125		1696	D 8M	212		3600	D 8M	450		
1040	D 8M	130		1760	D 8M	220		4400	D 8M	550		
1120	D 8M	140		1792	D 8M	224						

ÇİFT TARAFLI ZAMAN KAYIŞLARI

DSTD 8M (8 MM)

USD

BELT NO KAYIŞ NO	TİP TYPE	DİŞ TEETH	1 MM	BELT NO KAYIŞ NO	TİP TYPE	DİŞ TEETH	1 MM	BELT NO KAYIŞ NO	TİP TYPE	DİŞ TEETH	1 MM
480	DS 8M	60		1032	DS 8M	129		1400	DS 8M	175	
520	DS 8M	65		1040	DS 8M	130		1424	DS 8M	178	
560	DS 8M	70		1056	DS 8M	132		1440	DS 8M	180	
584	DS 8M	73		1096	DS 8M	137		1480	DS 8M	185	
600	DS 8M	75		1120	DS 8M	140		1520	DS 8M	190	
632	DS 8M	79		1136	DS 8M	142		1600	DS 8M	200	
640	DS 8M	80		1152	DS 8M	144		1624	DS 8M	203	
656	DS 8M	82		1160	DS 8M	145		1680	DS 8M	210	
672	DS 8M	84		1168	DS 8M	146		1728	DS 8M	216	
680	DS 8M	85		1184	DS 8M	148		1760	DS 8M	220	
712	DS 8M	89		1192	DS 8M	149		1776	DS 8M	222	
720	DS 8M	90		1200	DS 8M	150		1800	DS 8M	225	
728	DS 8M	91		1216	DS 8M	152		1880	DS 8M	235	
760	DS 8M	95		1224	DS 8M	153		1952	DS 8M	244	
800	DS 8M	100		1240	DS 8M	155		2000	DS 8M	250	
840	DS 8M	105		1248	DS 8M	156		2120	DS 8M	265	
848	DS 8M	106		1256	DS 8M	157		2160	DS 8M	270	
880	DS 8M	110		1272	DS 8M	159		2240	DS 8M	280	
888	DS 8M	111		1280	DS 8M	160		2304	DS 8M	288	
896	DS 8M	112		1296	DS 8M	162		2400	DS 8M	300	
920	DS 8M	115		1304	DS 8M	163		2496	DS 8M	312	
944	DS 8M	118		1312	DS 8M	164		2600	DS 8M	325	
952	DS 8M	119		1344	DS 8M	168		2800	DS 8M	350	
960	DS 8M	120		1352	DS 8M	169		3200	DS 8M	400	
984	DS 8M	123		1384	DS 8M	173		3720	DS 8M	465	
1000	DS 8M	125		1392	DS 8M	174		4400	DS 8M	550	



ÇİFT TARAFLI ZAMAN KAYIŞLARI

DHTD 14M (14 MM)

USD

BELT NO KAYIŞ NO	TİP TYPE	DİŞ TEETH	1 MM	BELT NO KAYIŞ NO	TİP TYPE	DİŞ TEETH	1 MM	BELT NO KAYIŞ NO	TİP TYPE	DİŞ TEETH	1 MM
1400	D 14M	100		2100	D 14M	150		3850	D 14M	275	
1610	D 14M	115		2240	D 14M	160		4326	D 14M	309	
1652	D 14M	118		2310	D 14M	165		4536	D 14M	324	
1750	D 14M	125		2450	D 14M	175		4578	D 14M	327	
1764	D 14M	126		2590	D 14M	185		4760	D 14M	340	
1778	D 14M	127		2660	D 14M	190		4956	D 14M	354	
1792	D 14M	128		2800	D 14M	200		5040	D 14M	360	
1806	D 14M	129		3108	D 14M	222		5320	D 14M	380	
1890	D 14M	135		3150	D 14M	225		5740	D 14M	410	
1932	D 14M	138		3304	D 14M	236		5936	D 14M	424	
1946	D 14M	139		3360	D 14M	240		6160	D 14M	440	
1960	D 14M	140		3500	D 14M	250		6860	D 14M	490	
2002	D 14M	143		3668	D 14M	262					

DSTD 14M (14 MM)

USD

BELT NO KAYIŞ NO	TİP TYPE	DİŞ TEETH	1 MM	BELT NO KAYIŞ NO	TİP TYPE	DİŞ TEETH	1 MM	BELT NO KAYIŞ NO	TİP TYPE	DİŞ TEETH	1 MM
1008	DS 14M	72		1764	DS 14M	126		2380	DS 14M	170	
1120	DS 14M	80		1806	DS 14M	129		2800	DS 14M	200	
1190	DS 14M	85		1890	DS 14M	135		3150	DS 14M	225	
1246	DS 14M	89		2002	DS 14M	143		3500	DS 14M	250	
1400	DS 14M	100		2100	DS 14M	150		3850	DS 14M	275	
1540	DS 14M	110		2240	DS 14M	160		4004	DS 14M	286	
1610	DS 14M	115		2310	DS 14M	165		4326	DS 14M	309	
1652	DS 14M	118									



KAUÇUK KANALLI KAYIŞLAR

Kanallı kayışlar yüksek hız yüksek aktarma oranı uygulamalarında klasik V kayışı yerine tercih edilir. Kayışın yekpare ve pürüzsüz yapısı titreşimi minimize eder. Sıcaklığa ve sürtünmeye dayanımı daha uzun ömürlü olmasını sağlar.



HIT Kanallı Kayış 25 PJ 500/1270

Kanal Sayısı

Tip/Kod

Kayış Uzunluğu inç/mm

TİP	PH	PJ	PK	PL	PM	PJ (Kalıp)
HATVE	1.6 mm	2.34 mm	3.56 mm	4.7 mm	9.4 mm	2.34 mm
KAYIŞ YÜKSEKLİĞİ	3 mm	3.5 mm	6 mm	9.5 mm	16.5 mm	3.5 mm
KANAL AĞIRLIĞI	5.9 g/m	8.4 g/m	20 g/m	30.9 g/m	124.1 g/m	8.4 g/m
MİN. KASNAK ÇAPI	13 mm	20 mm	40 mm	75 mm	180 mm	20 mm
MAX. KANAL SAYISI	305 Kanal	205 Kanal	135 Kanal	100/44 Kanal	50/32/18 Kanal	101/204 Kanal

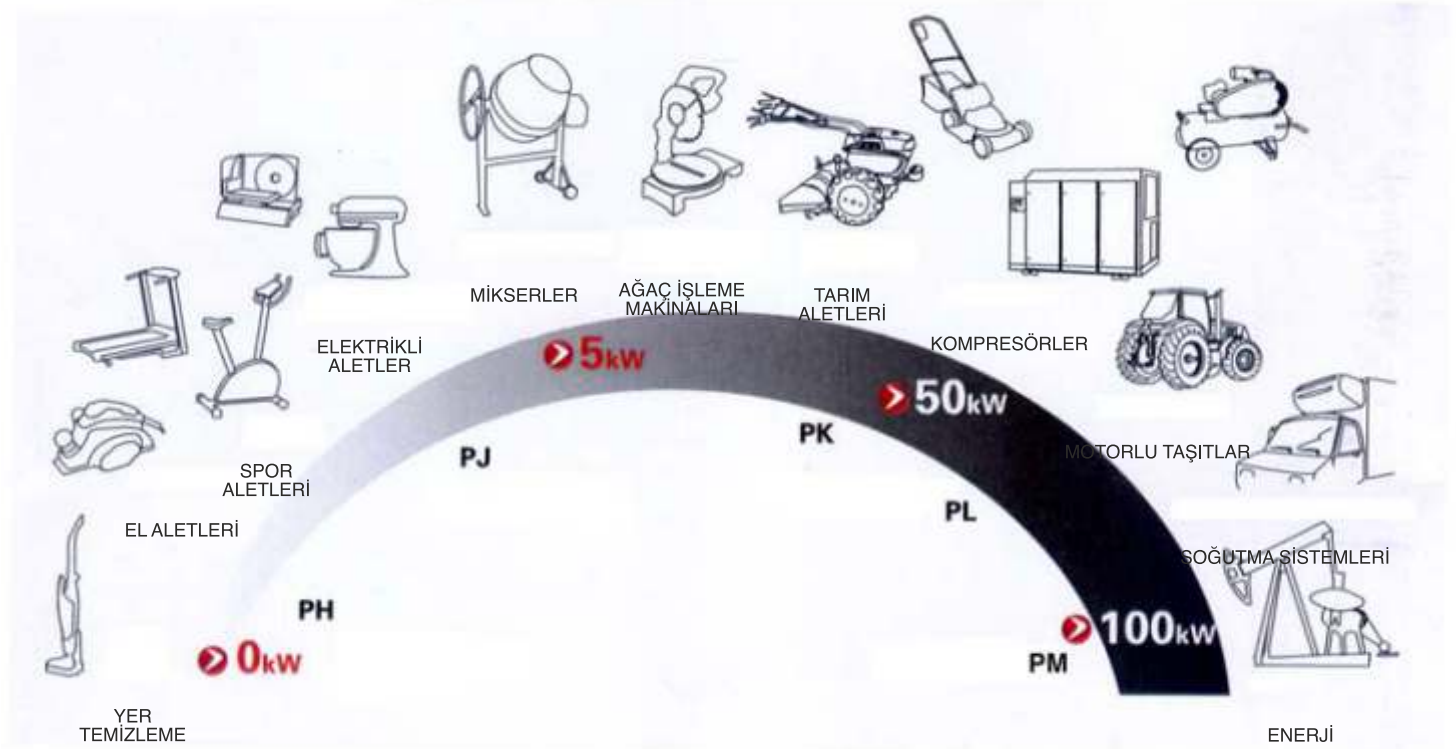

KAUÇUK KANALLI KAYIŞLAR

PH								USD			
TİP TYPE	ÇEVRE MM	ÇEVRE INCH	1 KANAL	TİP TYPE	ÇEVRE MM	ÇEVRE INCH	1 KANAL	TİP TYPE	ÇEVRE MM	ÇEVRE INCH	1 KANAL
PH	254	100	***	PH	660	260	***	PH	1295	510	***
PH	305	120	***	PH	686	270	***	PH	1321	520	***
PH	330	130	***	PH	762	300	***	PH	1575	620	***
PH	356	140	***	PH	787	310	***	PH	1600	630	***
PH	368	145	***	PH	813	320	***	PH	1676	660	***
PH	381	150	***	PH	820	323	***	PH	1727	680	***
PH	406	160	***	PH	838	330	***	PH	1803	710	***
PH	457	180	***	PH	864	340	***	PH	1829	720	***
PH	483	190	***	PH	965	380	***	PH	1860	732	***
PH	508	200	***	PH	1016	400	***	PH	1930	760	***
PH	533	210	***	PH	1080	425	***	PH	1956	770	***
PH	559	220	***	PH	1143	450	***	PH	2007	790	***
PH	597	235	***	PH	1219	480	***	PH	2057	810	***
PH	610	240	***	PH	1270	500	***	PH	2197	865	***
PH	635	250	***	PH	1287	507	***	PH	2375	935	***

PJ								USD			
TİP TYPE	ÇEVRE MM	ÇEVRE INCH	1 KANAL	TİP TYPE	ÇEVRE MM	ÇEVRE INCH	1 KANAL	TİP TYPE	ÇEVRE MM	ÇEVRE INCH	1 KANAL
PJ	292	115		PJ	940	370		PJ	1315	518	
PJ	305	120		PJ	965	380		PJ	1321	520	
PJ	330	130		PJ	991	390		PJ	1333	525	
PJ	343	135		PJ	995	392		PJ	1355	533	
PJ	356	140		PJ	1016	400		PJ	1372	540	
PJ	368	145		PJ	1041	410		PJ	1397	550	
PJ	381	150		PJ	1054	415		PJ	1428	562	
PJ	406	160		PJ	1067	420		PJ	1439	566	
PJ	432	170		PJ	1069	421		PJ	1473	580	
PJ	457	180		PJ	1080	425		PJ	1518	598	
PJ	483	190		PJ	1092	430		PJ	1549	610	
PJ	500	195		PJ	1105	435		PJ	1600	630	
PJ	508	200		PJ	1118	440		PJ	1651	650	
PJ	513	202		PJ	1123	442		PJ	1663	655	
PJ	533	210		PJ	1130	445		PJ	1752	690	
PJ	559	220		PJ	1143	450		PJ	1780	700	
PJ	584	230		PJ	1150	453		PJ	1854	730	
PJ	610	240		PJ	1168	460		PJ	1895	746	
PJ	635	250		PJ	1194	470		PJ	1910	752	
PJ	660	260		PJ	1200	472		PJ	1915	754	
PJ	686	270		PJ	1206	475		PJ	1930	760	
PJ	711	280		PJ	1219	480		PJ	1956	770	
PJ	724	285		PJ	1233	485		PJ	1965	774	
PJ	737	290		PJ	1244	490		PJ	1981	780	
PJ	762	300		PJ	1270	500		PJ	1992	784	
PJ	787	310		PJ	1280	504		PJ	2019	795	
PJ	813	320		PJ	1285	506		PJ	2083	820	
PJ	838	330		PJ	1287	507		PJ	2155	848	
PJ	864	340		PJ	1295	510		PJ	2210	870	
PJ	889	350		PJ	1301	512		PJ	2286	900	
PJ	914	360		PJ	1309	515		PJ	2337	920	
								PJ	2413	950	
								PJ	2489	980	

KAUÇUK KANALLI KAYIŞLAR

PL								USD			
TİP TYPE	ÇEVRE MM	ÇEVRE INCH	1 KANAL	TİP TYPE	ÇEVRE MM	ÇEVRE INCH	1 KANAL	TİP TYPE	ÇEVRE MM	ÇEVRE INCH	1 KANAL
PL	954	375		PL	1165	695		PL	2921	1150	
PL	991	390		PL	1803	710		PL	2997	1180	
PL	1041	410		PL	1842	725		PL	3086	1215	
PL	1075	423		PL	1943	765		PL	3124	1230	
PL	1168	460		PL	1981	780		PL	3289	1295	
PL	1185	466		PL	2019	795		PL	3327	1310	
PL	1194	470		PL	2070	815		PL	3493	1375	
PL	1270	500		PL	2096	825		PL	3696	1455	
PL	1295	510		PL	2134	840		PL	4051	1595	
PL	1334	525		PL	2197	865		PL	4191	1650	
PL	1346	530		PL	2235	880		PL	4470	1760	
PL	1372	540		PL	2324	915		PL	4623	1820	
PL	1397	550		PL	2362	930		PL	5029	1980	
PL	1422	560		PL	2476	975		PL	5385	2120	
PL	1499	590		PL	2515	990		PL	6096	2400	
PL	1562	615		PL	2705	1065					
PL	1613	635		PL	2743	1080					
PL	1664	665		PL	2845	1120					
PL	1715	675		PL	2896	1140					

PM								USD			
TİP TYPE	ÇEVRE MM	ÇEVRE INCH	1 KANAL	TİP TYPE	ÇEVRE MM	ÇEVRE INCH	1 KANAL	TİP TYPE	ÇEVRE MM	ÇEVRE INCH	1 KANAL
PM	2286	900	***	PM	5410	2130	***				
PM	2388	940	***	PM	6121	2410	***				
PM	2515	990	***	PM	6502	2560	***				
PM	2693	1060	***	PM	6883	2710	***				
PM	2832	1115	***	PM	7646	3010	***				
PM	2921	1150	***	PM	8408	3310	***				
PM	3010	1185	***	PM	9169	3610	***				
PM	3124	1230	***	PM	9931	3910	***				
PM	3327	1310	***	PM	10693	4210	***				
PM	3531	1390	***	PM	12217	4810	***				
PM	3556	1400	***	PM	13741	5410	***				
PM	3734	1470	***	PM	15266	6010	***				
PM	3854	1517	***								
PM	4089	1610	***								
PM	4191	1650	***								
PM	4470	1760	***								
PM	4648	1830	***								
PM	5029	1980	***								

KAUÇUK KANALLI KAYIŞLAR

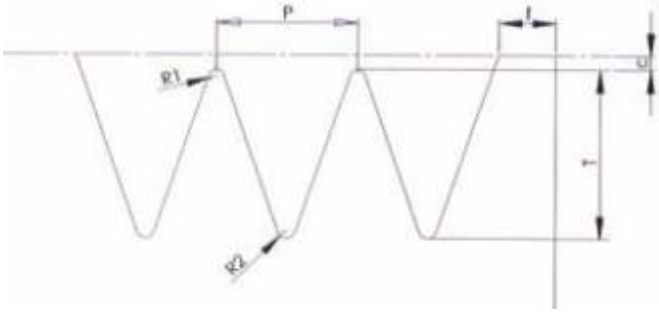

	PJ	PK	PL
P	2.34	3.56	4.7
r1 min.	0.24	0.25	0.4
r2 max.	0.4	0.5	0.4
f	1.8	2.5	3.3
T	2.21	3.75	5.11
c	1.2	1.5	3

PJ								EURO			
TİP TYPE	ÇEVRE MM	ÇEVRE INCH	1 KANAL	TİP TYPE	ÇEVRE MM	ÇEVRE INCH	1 KANAL	TİP TYPE	ÇEVRE MM	ÇEVRE INCH	1 KANAL
PJ	432	170		PJ	1143	450		PJ	2286	900	
PJ	457	180		PJ	1168	460		PJ	2337	920	
PJ	483	190		PJ	1194	470		PJ	2489	980	
PJ	508	200		PJ	1200	472					
PJ	559	220		PJ	1245	493					
PJ	584	230		PJ	1270	500					
PJ	610	240		PJ	1295	510					
PJ	660	260		PJ	1321	520					
PJ	711	280		PJ	1333	525					
PJ	762	300		PJ	1372	540					
PJ	813	320		PJ	1397	550					
PJ	838	330		PJ	1473	580					
PJ	864	340		PJ	1549	610					
PJ	914	380		PJ	1600	630					
PJ	965	380		PJ	1651	650					
PJ	1016	400		PJ	1854	730					
PJ	1054	415		PJ	1956	770					
PJ	1092	430		PJ	1981	780					

PL								EURO			
TİP TYPE	ÇEVRE MM	ÇEVRE INCH	1 KANAL	TİP TYPE	ÇEVRE MM	ÇEVRE INCH	1 KANAL	TİP TYPE	ÇEVRE MM	ÇEVRE INCH	1 KANAL
PL	991	390		PL	2134	840					
PL	1270	500		PL	2195	865					
PL	1333	525		PL	2324	915					
PL	1372	540		PL	2362	930					
PL	1397	550		PL	2477	975					
PL	1422	560		PL	2515	990					
PL	1562	615		PL	2705	1065					
PL	1613	635		PL	2997	1180					
PL	1664	665		PL	3124	1230					
PL	1715	675		PL	3327	1310					
PL	1765	695		PL	3492	1375					
PL	1841	725		PL	4051	1595					
PL	1943	765		PL	4622	1820					
PL	1981	780		PL	5029	1980					
PL	2020	795									

Üretim Standartları

KOD	Sonsuz Kalıp		FLEX Sonsuz	
	Max Genişlik	Min~Max(mm)	Max Genişlik	Min~Max(Metre)
T2.5	150 mm	82.5~1300	-	-
T5	150 mm	120~1955	100 mm	1.8~22 M
T10	150 mm	250~3040	150 mm	1.8~22 M
T20	150 mm	-	150 mm	1.8~22 M
AT5	150 mm	255~2000	100 mm	1.8~22 M
AT10	150 mm	250~2350	150 mm	1.8~22 M
AT20	200 mm	1,900	200 mm	1.8~22 M
MXL	150 mm	101.6~554.58	-	-
XL	150 mm	152.40~2000	-	-
L	150 mm	314.33~1847.85	101.6 mm	1.8~22 M
H	150 mm	584.2~2794	152.4 mm	1.8~22 M
XH	-	-	101.6 mm	1.8~22 M
2M	150 mm	64	-	-
3M	150 mm	117~1209	-	-
5M	150 mm	250~2500	100 mm	1.8~22 M
8M	150 mm	864	150 mm	1.8~22 M
10M	-	-	50 mm	1.8~22 M
14M	150 mm	-	100 mm	1.8~22 M
S2M	150 mm	192	-	-
S3M	150 mm	234~549	-	-
S5M	150 mm	335~625	100 mm	1.8~22 M
S8M	-	-	100 mm	1.8~22 M
S14M	-	-	100 mm	1.8~22 M
RPP5M	-	-	100 mm	1.8~22 M
RPP8M	-	-	100 mm	1.8~22 M
RPP14M	-	1764	100 mm	1.8~22 M
DT5	150 mm	410~1520	100 mm	1.8~22 M
DT10	150 mm	530~1880	100 mm	1.8~22 M
DAT10	-	-	100 mm	1.8~22 M
DMXL	150 mm	792	-	-
DXL	150 mm	381	-	-
DL	150 mm	-	-	-
DH	150 mm	-	100 mm	1.8~22 M
D3M	150 mm	597	-	-
D5M	150 mm	615~1110	100 mm	1.8~22 M
D8M	150 mm	1,680	100 mm	1.8~22 M
AT10 overLap	50 mm	-	50 mm	1.8~22 M
ATK10(13*8)	50 mm	-	50 mm	1.8~22 M
TK10(13*8)	50 mm	-	50 mm	1.8~22 M
TK10(6*4)NFT	25 mm	-	25 mm	1.8~22 M
HTDK8M(6*4)NFT	25 mm	-	25 mm	1.8~22 M

POLİÜRETAN ZAMAN KAYIŞLARI

PU T-2,5

USD

BELT NO KAYIŞ NO	TİP TYPE	DİŞ TEETH	1 MM	BELT NO KAYIŞ NO	TİP TYPE	DİŞ TEETH	1 MM	BELT NO KAYIŞ NO	TİP TYPE	DİŞ TEETH	1 MM
82.5	T-2,5	33	***	285	T-2,5	114	***	620	T-2,5	248	***
120	T-2,5	48	***	305	T-2,5	122	***	650	T-2,5	260	***
145	T-2,5	58	***	317.5	T-2,5	127	***	680	T-2,5	272	***
160	T-2,5	64	***	330	T-2,5	132	***	700	T-2,5	280	***
177.5	T-2,5	71	***	380	T-2,5	152	***	780	T-2,5	312	***
182.5	T-2,5	73	***	420	T-2,5	168	***	880	T-2,5	352	***
200	T-2,5	80	***	480	T-2,5	192	***	915	T-2,5	366	***
225	T-2,5	90	***	492.5	T-2,5	197	***	950	T-2,5	380	***
230	T-2,5	92	***	500	T-2,5	200	***	1185	T-2,5	474	***
245	T-2,5	98	***	600	T-2,5	240	***	1750	T-2,5	700	***
265	T-2,5	106	***								

PU T-5 ÇELİK TELLİ

USD

BELT NO KAYIŞ NO	TİP TYPE	DİŞ TEETH	1 MM	BELT NO KAYIŞ NO	TİP TYPE	DİŞ TEETH	1 MM	BELT NO KAYIŞ NO	TİP TYPE	DİŞ TEETH	1 MM
120	T-5	24		425	T-5	85		765	T-5	153	
150	T-5	30		440	T-5	88		780	T-5	156	
165	T-5	33		450	T-5	90		800	T-5	160	
185	T-5	37		455	T-5	91		810	T-5	162	
200	T-5	40		460	T-5	92		815	T-5	163	
215	T-5	43		465	T-5	93		825	T-5	165	
220	T-5	44		475	T-5	95		840	T-5	168	
225	T-5	45		480	T-5	96		850	T-5	170	
245	T-5	49		500	T-5	100		875	T-5	175	
250	T-5	50		510	T-5	102		885	T-5	177	
255	T-5	51		525	T-5	105		900	T-5	180	
260	T-5	52		545	T-5	109		920	T-5	184	
270	T-5	54		550	T-5	110		940	T-5	188	
275	T-5	55		560	T-5	112		975	T-5	195	
280	T-5	56		575	T-5	115		990	T-5	198	
295	T-5	59		590	T-5	118		1000	T-5	200	
300	T-5	60		600	T-5	120		1045	T-5	209	
305	T-5	61		610	T-5	122		1075	T-5	215	
320	T-5	64		620	T-5	124		1100	T-5	220	
325	T-5	65		625	T-5	125		1140	T-5	228	
330	T-5	66		630	T-5	126		1200	T-5	240	
340	T-5	68		640	T-5	128		1215	T-5	243	
350	T-5	70		650	T-5	130		1275	T-5	255	
355	T-5	71		660	T-5	132		1280	T-5	256	
360	T-5	72		670	T-5	134		1315	T-5	263	
365	T-5	73		690	T-5	138		1350	T-5	270	
375	T-5	75		695	T-5	139		1355	T-5	271	
390	T-5	78		700	T-5	140		1380	T-5	276	
400	T-5	80		720	T-5	144		1440	T-5	288	
410	T-5	82		725	T-5	145		1580	T-5	316	
420	T-5	84		740	T-5	148		1900	T-5	380	
				750	T-5	150		1955	T-5	391	

POLİÜRETAN ZAMAN KAYIŞLARI

PU T-10								USD			
BELT NO KAYIŞ NO	TİP TYPE	DİŞ TEETH	1 MM	BELT NO KAYIŞ NO	TİP TYPE	DİŞ TEETH	1 MM	BELT NO KAYIŞ NO	TİP TYPE	DİŞ TEETH	1 MM
260	T-10	26		880	T-10	88		1440	T-10	144	
370	T-10	37		890	T-10	89		1450	T-10	145	
400	T-10	40		900	T-10	90		1460	T-10	146	
410	T-10	41		910	T-10	91		1500	T-10	150	
440	T-10	44		920	T-10	92		1560	T-10	156	
450	T-10	45		960	T-10	96		1600	T-10	160	
480	T-10	48		970	T-10	97		1610	T-10	161	
490	T-10	49		980	T-10	98		1640	T-10	164	
500	T-10	50		1000	T-10	100		1700	T-10	170	
530	T-10	53		1010	T-10	101		1750	T-10	175	
550	T-10	55		1050	T-10	105		1780	T-10	178	
560	T-10	56		1080	T-10	108		1800	T-10	180	
600	T-10	60		1100	T-10	110		1880	T-10	188	
610	T-10	61		1110	T-10	111		1960	T-10	196	
630	T-10	63		1140	T-10	114		1980	T-10	198	
650	T-10	65		1150	T-10	115		2000	T-10	200	
660	T-10	66		1200	T-10	120		2020	T-10	202	
690	T-10	69		1210	T-10	121		2100	T-10	210	
700	T-10	70		1240	T-10	124		2120	T-10	212	
720	T-10	72		1250	T-10	125		2160	T-10	216	
730	T-10	73		1300	T-10	130		2170	T-10	217	
750	T-10	78		1320	T-10	132		2200	T-10	220	
780	T-10	80		1350	T-10	135		2250	T-10	225	
800	T-10	81		1360	T-10	136		2500	T-10	250	
810	T-10	84		1390	T-10	139		2800	T-10	280	
840	T-10	85		1400	T-10	140		3100	T-10	310	
850	T-10	88		1420	T-10	142		3300	T-10	330	

PU T-20								USD			
BELT NO KAYIŞ NO	TİP TYPE	DİŞ TEETH	1 MM	BELT NO KAYIŞ NO	TİP TYPE	DİŞ TEETH	1 MM	BELT NO KAYIŞ NO	TİP TYPE	DİŞ TEETH	1 MM
1300	T-20	65	***	1880	T-20	94	***	2400	T-20	120	***
1460	T-20	73	***	2000	T-20	100	***	2500	T-20	125	***
1860	T-20	93	***	2360	T-20	118	***	2600	T-20	130	***

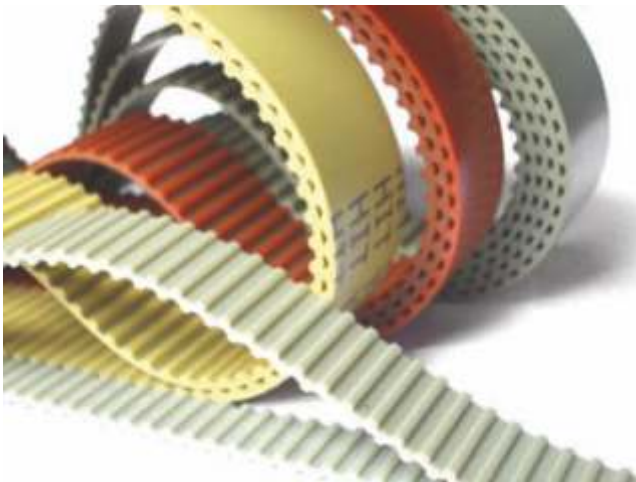

POLİÜRETAN ZAMAN KAYIŞLARI

PU AT-5								USD			
BELT NO KAYIŞ NO	TİP TYPE	DİŞ TEETH	1 MM	BELT NO KAYIŞ NO	TİP TYPE	DİŞ TEETH	1 MM	BELT NO KAYIŞ NO	TİP TYPE	DİŞ TEETH	1 MM
225	AT-5	45	***	500	AT-5	100	***	780	AT-5	156	***
255	AT-5	51	***	525	AT-5	105	***	825	AT-5	165	***
280	AT-5	56	***	545	AT-5	109	***	860	AT-5	172	***
300	AT-5	60	***	600	AT-5	120	***	890	AT-5	178	***
330	AT-5	66	***	610	AT-5	122	***	950	AT-5	190	***
335	AT-5	67	***	620	AT-5	124	***	975	AT-5	195	***
340	AT-5	68	***	630	AT-5	126	***	1050	AT-5	210	***
375	AT-5	75	***	660	AT-5	132	***	1125	AT-5	225	***
390	AT-5	78	***	665	AT-5	133	***	1380	AT-5	276	***
420	AT-5	84	***	695	AT-5	139	***	1500	AT-5	300	***
450	AT-5	90	***	710	AT-5	142	***	1750	AT-5	350	***
455	AT-5	91	***	720	AT-5	144	***	2000	AT-5	400	***
480	AT-5	96	***	750	AT-5	150	***				

PU AT-10								USD			
BELT NO KAYIŞ NO	TİP TYPE	DİŞ TEETH	1 MM	BELT NO KAYIŞ NO	TİP TYPE	DİŞ TEETH	1 MM	BELT NO KAYIŞ NO	TİP TYPE	DİŞ TEETH	1 MM
500	AT-10	50	***	890	AT-10	89	***	1320	AT-10	132	***
560	AT-10	56	***	920	AT-10	92	***	1390	AT-10	139	***
580	AT-10	58	***	960	AT-10	96	***	1400	AT-10	140	***
600	AT-10	60	***	980	AT-10	98	***	1420	AT-10	142	***
610	AT-10	61	***	1010	AT-10	101	***	1480	AT-10	148	***
630	AT-10	63	***	1050	AT-10	105	***	1500	AT-10	150	***
660	AT-10	66	***	1080	AT-10	108	***	1600	AT-10	160	***
700	AT-10	70	***	1100	AT-10	110	***	1630	AT-10	163	***
730	AT-10	73	***	1150	AT-10	115	***	1700	AT-10	170	***
780	AT-10	78	***	1200	AT-10	120	***	1720	AT-10	172	***
800	AT-10	80	***	1210	AT-10	121	***	1800	AT-10	180	***
810	AT-10	81	***	1250	AT-10	125	***	1860	AT-10	186	***
840	AT-10	84	***	1280	AT-10	128	***	1940	AT-10	194	***
880	AT-10	88	***	1300	AT-10	130	***				



PU DT-5 ÇELİK TELLİ

USD

BELT NO KAYIŞ NO	TİP TYPE	DİŞ TEETH	1 MM	BELT NO KAYIŞ NO	TİP TYPE	DİŞ TEETH	1 MM	BELT NO KAYIŞ NO	TİP TYPE	DİŞ TEETH	1 MM
300	DT-5	60		620	DT-5	124		850	DT-5	170	
410	DT-5	82		625	DT-5	125		860	DT-5	172	
460	DT-5	92		650	DT-5	130		900	DT-5	180	
480	DT-5	96		700	DT-5	140		940	DT-5	188	
510	DT-5	102		750	DT-5	150		1075	DT-5	215	
515	DT-5	103		755	DT-5	151		1100	DT-5	220	
525	DT-5	105		775	DT-5	155		1325	DT-5	265	
530	DT-5	106		800	DT-5	160		1350	DT-5	270	
550	DT-5	110		815	DT-5	163		1520	DT-5	304	
590	DT-5	118									

PU DT-10

USD

BELT NO KAYIŞ NO	TİP TYPE	DİŞ TEETH	1 MM	BELT NO KAYIŞ NO	TİP TYPE	DİŞ TEETH	1 MM	BELT NO KAYIŞ NO	TİP TYPE	DİŞ TEETH	1 MM
260	DT-10	26		1010	DT-10	101		1420	DT-10	142	
530	DT-10	53		1080	DT-10	108		1500	DT-10	150	
630	DT-10	63		1100	DT-10	110		1610	DT-10	161	
660	DT-10	66		1210	DT-10	121		1700	DT-10	170	
700	DT-10	70		1240	DT-10	124		1750	DT-10	175	
720	DT-10	72		1250	DT-10	125		1800	DT-10	180	
800	DT-10	80		1300	DT-10	130		1880	DT-10	188	
840	DT-10	84		1320	DT-10	132		1960	DT-10	196	
900	DT-10	90		1350	DT-10	135		2120	DT-10	212	
910	DT-10	91		1390	DT-10	139		2250	DT-10	225	
980	DT-10	98									

PU TT-5 KEVLAR

USD

BELT NO KAYIŞ NO	TİP TYPE	DİŞ TEETH	1 MM	BELT NO KAYIŞ NO	TİP TYPE	DİŞ TEETH	1 MM	BELT NO KAYIŞ NO	TİP TYPE	DİŞ TEETH	1 MM
6000	TT-5	1200		8200	TT-5	1640	***	10400	TT-5	2080	***
6200	TT-5	1240		8400	TT-5	1680	***	10600	TT-5	2120	***
6400	TT-5	1280		8600	TT-5	1720	***	10800	TT-5	2160	***
6600	TT-5	1320		8800	TT-5	1760	***	11000	TT-5	2200	***
6800	TT-5	1360		9000	TT-5	1800	***	11200	TT-5	2240	***
7000	TT-5	1400		9200	TT-5	1840	***	11400	TT-5	2280	***
7200	TT-5	1440		9400	TT-5	1880	***	11600	TT-5	2320	***
7400	TT-5	1480		9600	TT-5	1920	***	11800	TT-5	2360	***
7600	TT-5	1520		9800	TT-5	1960	***	12000	TT-5	2400	***
7800	TT-5	1560		10000	TT-5	2000	***	13800	TT-5	2760	***
8000	TT-5	1600		10200	TT-5	2040	***	14000	TT-5	2800	***

POLİÜRETAN AÇIK UÇLU ZAMAN KAYIŞLARI

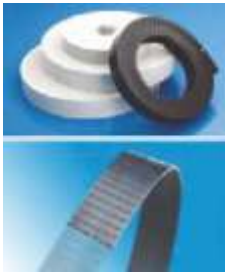
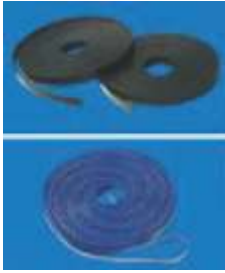
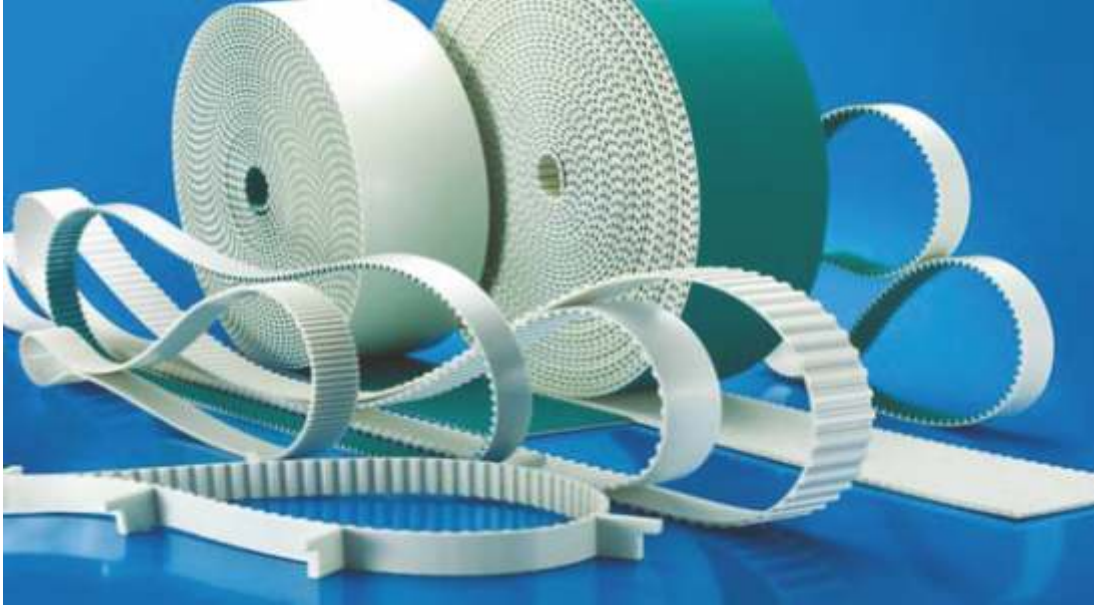

Tip	Kalınlık Tolerans	Hatve	Diş Yüksekliği	Kırılma Direnci Çelik /10 mm	Kırılma Direnci Kevlar /10 mm	Ağırlık mm/mt
XL	2,3 +/-0,3 mm	5.080 mm	1.270 mm	1125 N	1500 N	2.36 g
L	3,6 +/-0,3 mm	9.525 mm	1.910 mm	2400 N	2600 N	3.7 g
H	4,3 +/-0,3 mm	12.700 mm	2.290 mm	4200 N	3500 N	4.3 g
XH	11,2 +/-0,5 mm	22.225 mm	6.350 mm	6080 N	6000 N	10.4 g
T5	2,2 +/-0,15 mm	5.00 mm	1.20 mm	1500 N	2420 N	2.2 g
T10	4,5 +/-0,3 mm	10.00 mm	2.50 mm	3200 N	3240 N	4.6 g
T20	8 +/-0,45 mm	20.00 mm	5.00 mm	5600 N	5500 N	7.4 g
AT5	2,7 +/-0,2 mm	5.00 mm	1.20 mm	2000 N	2000 N	3.2 g
AT10	4,5 +/-0,3 mm	10.00 mm	2.50 mm	5900 N	5800 N	5.8 g
AT20	8 +/-0,45 mm	20.00 mm	5.00 mm	7600 N	7500 N	9.6 g
H3M	2,2 +/-0,15 mm	3.00 mm	1.17 mm	1250 N	1500 N	2.4 g
H5M	3,6 +/-0,2 mm	5.00 mm	2.06 mm	3200 N	3600 N	3.5 g
H8M	5,6 +/-0,3 mm	8.00 mm	3.36 mm	5700 N	5600 N	6.5 g
H14M	10 +/-0,45 mm	14.00 mm	6.02 mm	8200 N	7500 N	10 g
S5M	3,4 +/-0,25 mm	5.00 mm	1.91 mm	3200 N	3600 N	3.3 g
S8M	5,1 +/-0,25 mm	8.00 mm	3.05 mm	5700 N	5600 N	6.5 g
RPP5M	3,8 +/-0,2 mm	5.00 mm	1.95 mm	3200 N	3600 N	4 g
RPP8M	5,4 +/-0,3 mm	8.00 mm	3.20 mm	5700 N	5600 N	6.6 g
RPP14M	10 +/-0,4 mm	14.00 mm	6.00 mm	8200 N	7500 N	11.8 g

HIT PU Zaman Kayışı 25 T10 X 100M

Kayış Genişliği mm _____
Tip/Section _____
Rulo Uzunluğu mt _____

POLİÜRETAN AÇIK UÇLU ZAMAN KAYIŞLARI

												USD
TİP TYPE	GENİŞLİK WIDTH inch	GENİŞLİK WIDTH mm	1 MM	TİP TYPE	GENİŞLİK WIDTH mm	RULO ROLL mt	1 MM	TİP TYPE	GENİŞLİK WIDTH mm	RULO ROLL mt	1 MM	
MXL	025"	6.35		2M-S2M	6			T 2,5	6			
MXL	031"	7.87		2M-S2M	10			T 2,5	10			
MXL	037"	9.4		2M-S2M	25			T 2,5	15			
MXL	050"	12.7						T 2,5	25			
								T 5	6			
				3M-S3M	6			T 5	10			
XL	025"	6.35		3M-S3M	9			T 5	16			
XL	031"	7.87		3M-S3M	12			T 5	25			
XL	037"	9.4		3M-S3M	15			T 5	32			
XL	050"	12.7		3M-S3M	25			T 5	50			
								T 10	12			
								T 10	16			
L	050"	12.7		5M-S5M	10			T 10	25			
L	075"	19.05		5M-S5M	15			T 10	32			
L	100"	25.4		5M-S5M	25			T 10	50			
L	150"	38.1		5M-S5M	50			T 10	75			
L	200"	50.8		5M-S5M	100			T 10	100			
L	300"	76.2										
								T 20	50			
								T 20	75			
				8M-S8M	10			T 20	100			
H	050"	12.7		8M-S8M	15			T 20	150			
H	075"	19.05		8M-S8M	20							
H	100"	25.4		8M-S8M	30			AT 5	10			
H	150"	38.1		8M-S8M	50			AT 5	16			
H	200"	50.8		8M-S8M	85			AT 5	25			
H	300"	76.2		8M-S8M	100			AT 5	32			
								AT 5	50			
								AT 10	6			
XH	200"	50.8		14M-S14M	40			AT 10	25			
XH	300"	76.2		14M-S14M	55			AT 10	32			
XH	400"	101.6		14M-S14M	85			AT 10	50			
XH	600"	152.4		14M-S14M	115			AT 10	75			
								AT 10	100			
								AT 10	150			
								AT 20	25			
								AT 20	32			
								AT 20	50			
								AT 20	100			
								AT 20	150			

USD			
TİP TYPE	GENİŞLİK WIDTH mm	RULO ROLL mt	1 MM
P1	10	50	***
P1	20	50	***
P1	50	50	***
P2	25	100	***
P2	30	100	***
P2	50	50	***
P2	75	50	***
P2	100	50	***
P3	25	100	***
P3	50	50	***
P3	100	50	***
P4	25	50	***
P4	50	50	***
P4	100	50	***



Özellikler

- Pürüzsüz, titreşimsiz sistemler
- Küçük kasnak çapları
- Yüksek direnç düşük uzama
- Flanşlı kasnaklarda kolay aktarma
- Kevlar® veya çelik kord
- Yağlama gerektirmez
- Gergi gerektirmez

Uygulamalar

- Yük kaldırma ve indirme sistemlerinde
- Düzgün ve doğrusal sistemlerde
- Gergi ve uzama istenmeyen sistemlerde
- Standart top metrajları -50 M / 100M
- Kayış iç yapısı - Galvaniz/Paslanmaz çelik/Naylon Kevlar /Karbon kordlar
- Kayış rengi - Siyah/beyaz/kırmızı/yeşil/mavi/şeffaf.
- Çalışma sıcaklığı -30 C 'den +80 C'ye kadar.



HIT PU Düz kayış 25 3000 2

Genişlik mm _____
Uzunluk mm _____
Kalınlık mm _____

KAUÇUK KANALLI KAYIŞLAR

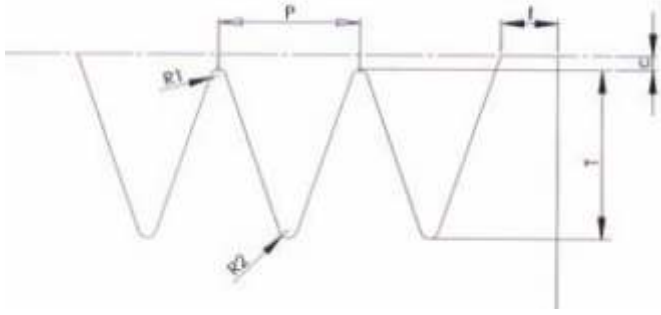

	PJ	PK	PL
P	2.34	3.56	4.7
r1 min.	0.24	0.25	0.4
r2 max.	0.4	0.5	0.4
f	1.8	2.5	3.3
T	2.21	3.75	5.11
c	1.2	1.5	3

PJ								EURO			
TİP TYPE	ÇEVRE MM	ÇEVRE INCH	1 KANAL	TİP TYPE	ÇEVRE MM	ÇEVRE INCH	1 KANAL	TİP TYPE	ÇEVRE MM	ÇEVRE INCH	1 KANAL
PJ	432	170		PJ	1143	450		PJ	2286	900	
PJ	457	180		PJ	1168	460		PJ	2337	920	
PJ	483	190		PJ	1194	470		PJ	2489	980	
PJ	508	200		PJ	1200	472					
PJ	559	220		PJ	1245	493					
PJ	584	230		PJ	1270	500					
PJ	610	240		PJ	1295	510					
PJ	660	260		PJ	1321	520					
PJ	711	280		PJ	1333	525					
PJ	762	300		PJ	1372	540					
PJ	813	320		PJ	1397	550					
PJ	838	330		PJ	1473	580					
PJ	864	340		PJ	1549	610					
PJ	914	380		PJ	1600	630					
PJ	965	380		PJ	1651	650					
PJ	1016	400		PJ	1854	730					
PJ	1054	415		PJ	1956	770					
PJ	1092	430		PJ	1981	780					

PL								EURO			
TİP TYPE	ÇEVRE MM	ÇEVRE INCH		TİP TYPE	ÇEVRE MM	ÇEVRE INCH		TİP TYPE	ÇEVRE MM	ÇEVRE INCH	1 KANAL
PL	991	390		PL	2134	840					
PL	1270	500		PL	2195	865					
PL	1333	525		PL	2324	915					
PL	1372	540		PL	2362	930					
PL	1397	550		PL	2477	975					
PL	1422	560		PL	2515	990					
PL	1562	615		PL	2705	1065					
PL	1613	635		PL	2997	1180					
PL	1664	665		PL	3124	1230					
PL	1715	675		PL	3327	1310					
PL	1765	695		PL	3492	1375					
PL	1841	725		PL	4051	1595					
PL	1943	765		PL	4622	1820					
PL	1981	780		PL	5029	1980					
PL	2020	795									

											USD	
TİP TYPE	GENİŞLİK WIDTH inch	GENİŞLİK WIDTH mm	1 MM	TİP TYPE	GENİŞLİK WIDTH mm	RULO ROLL mt	1 MM	TİP TYPE	GENİŞLİK WIDTH mm	RULO ROLL mt	1 MM	
MXL	025"	6.35	***	2M-S2M	6		***	T 2,5	6		***	
MXL	031"	7.87	***	2M-S2M	10		***	T 2,5	10		***	
MXL	037"	9.4	***	2M-S2M	25		***	T 2,5	15		***	
MXL	050"	12.7	***					T 2,5	25		***	
				3M-S3M	6		***	T 5	6		***	
XL	025"	6.35	***	3M-S3M	9		***	T 5	10		***	
XL	031"	7.87	***	3M-S3M	12		***	T 5	16		***	
XL	037"	9.4	***	3M-S3M	15		***	T 5	25		***	
XL	050"	12.7	***	3M-S3M	25		***	T 5	32		***	
								T 5	50		***	
L	050"	12.7	***	5M-S5M	10		***	T 10	12		***	
L	075"	19.05	***	5M-S5M	15		***	T 10	16		***	
L	100"	25.4	***	5M-S5M	25		***	T 10	25		***	
L	150"	38.1	***	5M-S5M	50		***	T 10	32		***	
L	200"	50.8	***					T 10	50		***	
L	300"	76.2	***					T10	75		***	
								T10	100		***	
				8M-S8M	10		***					
				8M-S8M	15		***					
H	050"	12.7	***	8M-S8M	20		***					
H	075"	19.05	***	8M-S8M	30		***					
H	100"	25.4	***	8M-S8M	50		***					
H	150"	38.1	***	8M-S8M	60		***					
H	200"	50.8	***									
H	300"	76.2	***									

POLİÜRETAN AÇIK UÇLU KAYIŞLAR

Çap	Renk	Yüzey	Min. Çap	Rulo mt
Ø1.5/R	Yeşil	Pürüzlü	20 mm	400
Ø2/R	Yeşil	Pürüzlü	20 mm	400
Ø3/R	Yeşil	Pürüzlü	30 mm	400
Ø4/R	Yeşil	Pürüzlü	40 mm	200
Ø5/R	Yeşil	Pürüzlü	50 mm	200
Ø6/R	Yeşil	Pürüzlü	60 mm	200
Ø7/R	Yeşil	Pürüzlü	70 mm	100
Ø8/R	Yeşil	Pürüzlü	80 mm	100
Ø9/R	Yeşil	Pürüzlü	90 mm	100
Ø10/R	Yeşil	Pürüzlü	100 mm	50
Ø12/R	Yeşil	Pürüzlü	120 mm	30
Ø15/R	Yeşil	Pürüzlü	150 mm	30
Ø18/R	Yeşil	Pürüzlü	180 mm	30
Ø1.5/S	Kırmızı	Pürüzsüz	20 mm	400
Ø2/S	Kırmızı	Pürüzsüz	20 mm	400
Ø3/S	Kırmızı	Pürüzsüz	30 mm	400
Ø4/S	Kırmızı	Pürüzsüz	40 mm	200
Ø5/S	Kırmızı	Pürüzsüz	50 mm	200
Ø6/S	Kırmızı	Pürüzsüz	60 mm	200
Ø7/S	Kırmızı	Pürüzsüz	70 mm	100
Ø8/S	Kırmızı	Pürüzsüz	80 mm	100
Ø9/S	Kırmızı	Pürüzsüz	90 mm	100
Ø10/S	Kırmızı	Pürüzsüz	100 mm	50
Ø12/S	Kırmızı	Pürüzsüz	120 mm	30
Ø15/S	Kırmızı	Pürüzsüz	150 mm	30
Ø18/S	Kırmızı	Pürüzsüz	180 mm	30



Yüzey: Pürüzlü Renk: Yeşil Sertlik: 88A
Uygulama Sıcaklığı: -35 C +75 C



Yüzey: Pürüzsüz Renk: Kırmızı Sertlik: 88A
Uygulama Sıcaklığı: -35 C +75 C



Yüzey: Pürüzsüz Renk: Turuncu Sertlik: 85A
Uygulama Sıcaklığı: -35 C +75 C



V-Tipi	Yüzey	Ölçü	Min. Çap	Rulo
Z/ 10	Pürüzsüz	10 x 5.5mm	65 mm	100 M
A/ 13	Pürüzsüz	13 x 9 mm	85 mm	30 M
B/ 17	Pürüzsüz	17 x 11.5 mm	120 mm	30 M
C/ 22	Pürüzsüz	22 x 14 mm	150 mm	30 M
D/ 32	Pürüzsüz	32 x 20 mm	210 mm	30 M
PentaTop				
A/13	Pürüzsüz	13 x 16 mm	170 mm	30 M
B/ 17	Pürüzsüz	17 x 19.5 mm	205 mm	30 M
C/ 22	Pürüzsüz	22 x 27 mm	295 mm	30 M
RidgeTop				
RA/ 13	Pürüzsüz	13 x 16 mm	170 mm	30 M
RB/ 17	Pürüzsüz	17 x 19.5 mm	205 mm	30 M
RC/ 22	Pürüzsüz	22 x 24.5 mm	295 mm	30 M



POLIÜRETAN AÇIK UÇLU KAYIŞLAR

										USD
TİP TYPE	ÇAP DIAMETER mm	RULO ROLL mt	1 MM	TİP TYPE	ÇAP DIAMETER mm	RULO ROLL mt	1 MM	TİP TYPE	ÇAP DIAMETER mm	1 MM
YUVARLAK	2	400		V-TİPİ	10	100	5,72	YUVARLAK	5x2	***
88 SHORE A	3	400		90 SHORE A	13	30	7,00	75 SHORE A	6x2.5	***
YEŞİL	4	200		TAKVİYESİZ	17	30	9,75	ORTASI DELİK	8x3.2	***
PÜRÜZLÜ	5	200		KIRMIZI	22	30	14,50	PÜRÜZSÜZ	10x4	***
	6	200			32	30	***	KIRMIZI	12x5	***
	7	100								
	8	100		V-TİPİ	10	100	***			
	9	100		80 SHORE A	13	30	***	YUVARLAK	5x2	***
	10	50		TAKVİYELİ	17	30	***	85 SHORE A	6x2.5	***
	12	30		BEJ	22	30	***	ORTASI DELİK	8x3.2	***
	15	30			32	30	***	PÜRÜZLÜ	10x4	***
	18	30						YEŞİL	12x5	***
YUVARLAK	2	400		V-TİPİ	13	30	***			
88 SHORE A	3	400		90 SHORE A	17	30	***	YUVARLAK	5x2	***
TURUNCU	4	200		TAKVİYESİZ	22	30	***	90 SHORE A	6x2.5	***
PÜRÜZSÜZ	5	200		KIRMIZI				ORTASI DELİK	8x3.2	***
	6	200		SUPERGRIP				PÜRÜZSÜZ	10x4	***
	7	100						BEYAZ	12x5	***
	8	100		V-TİPİ	13	30	***			
	9	100		80 SHORE A	17	30	***			
	10	50		TAKVİYELİ	22	30	***			
	12	30		KIRMIZI						
	15	30		SUPERGRIP						
	18	30								
				BEŞGEN	13	30	***			
				V-TİPİ	17	30	***			
				80 SHORE A	22	30	***			
				TAKVİYELİ						
				TAKVİYESİZ						
				RİDGETOP	13	30	***			
				V BELTS	17	30	***			
				80 SHORE A	22	30	***			
				TAKVİYELİ						
				TAKVİYESİZ						

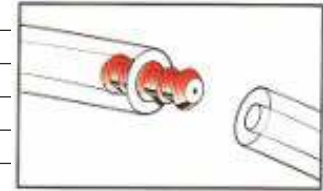

PROFİLLER

13 x 6

22 x 8

28 x 8

33 x 9

37 x 10

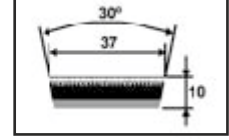
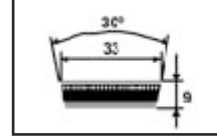
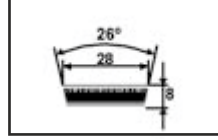
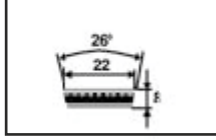
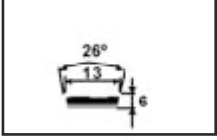

42 x 11

46 x 12

55 x 16

70 x 20

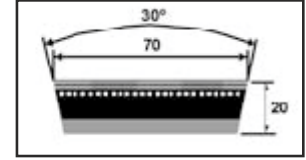
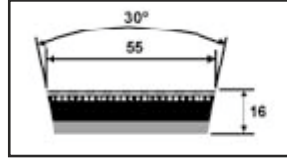
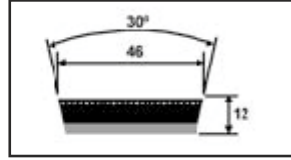
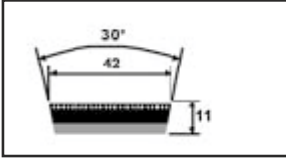

Varyatör Kayışları:

Çok küçük çapta kullanıma uygun,
Yüksek performanslı,
Uzun ömürlü,
Sabit kayış geometrili,
-35 C ' den, +100 C ' ye kadar dayanım,
Yağ ve toza dayanıklı,
Antistatik'tir .



KAUÇUK VARYATÖR KAYIŞLARI

PROFİL 13 x 6						USD		
Profil	Ölçü Li (mm)		Profil	Ölçü Li (mm)		Profil	Ölçü Li (mm)	
13 x 6	465	***	13 x 6	850	***			
13 x 6	500	***	13 x 6	900	***			
13 x 6	525	***	13 x 6	950	***			
13 x 6	550	***	13 x 6	1000	***			
13 x 6	575	***	13 x 6	1060	***			
13 x 6	600	***	13 x 6	1120	***			
13 x 6	625	***	13 x 6	1180	***			
13 x 6	650	***	13 x 6	1200	***			
13 x 6	700	***	13 x 6	1250	***			
13 x 6	725	***	13 x 6	1320	***			
13 x 6	750	***	13 x 6	1400	***			
13 x 6	800	***	13 x 6	1500	***			

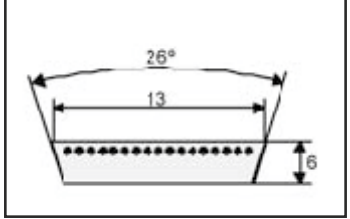

PROFİL 22 x 8			PROFİL 23 x 10					
Profil	Ölçü Li (mm)		Profil	Ölçü Li (mm)		Profil	Ölçü Li (mm)	
22 x 8	485	***	22 x 8	800	***	23 x 10	760	***
22 x 8	500	***	22 x 8	850	***	23 x 10	813	***
22 x 8	525	***	22 x 8	900	***	23 x 10	865	***
22 x 8	550	***	22 x 8	950	***			
22 x 8	575	***	22 x 8	1000	***			
22 x 8	600	***	22 x 8	1060	***			
22 x 8	625	***	22 x 8	1120	***			
22 x 8	650	***	22 x 8	1180	***			
22 x 8	675	***	22 x 8	1200	***			
22 x 8	700	***	22 x 8	1250	***			
22 x 8	725	***	22 x 8	1320	***			
22 x 8	750	***	22 x 8	1400	***			
22 x 8	775	***	22 x 8	1500	***			

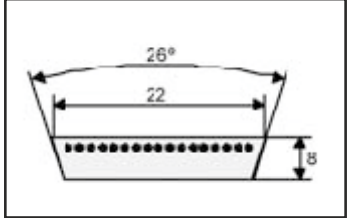

PROFİL 28 x 8			PROFİL 28 x 13					
Profil	Ölçü Li (mm)		Profil	Ölçü Li (mm)		Profil	Ölçü Li (mm)	
28 x 8	525	***	28 x 8	900	***	28 x 13	1000	***
28 x 8	550	***	28 x 8	950	***	28 x 13	1100	***
28 x 8	575	***	28 x 8	1000	***	28 x 13	1210	***
28 x 8	600	***	28 x 8	1060	***	28 x 13	1300	***
28 x 8	625	***	28 x 8	1120	***	28 x 13	1400	***
28 x 8	650	***	28 x 8	1180	***			
28 x 8	675	***	28 x 8	1200	***			
28 x 8	700	***	28 x 8	1250	***			
28 x 8	725	***	28 x 8	1320	***			
28 x 8	750	***	28 x 8	1400	***			
28 x 8	775	***	28 x 8	1500	***			
28 x 8	800	***	28 x 8	1600	***			
28 x 8	850	***	28 x 8	1700	***			

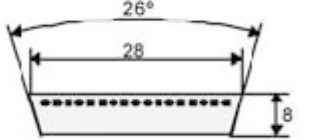

KAUÇUK VARYATÖR KAYIŞLARI

PROFİL 30 x 10			PROFİL 32 x 10			USD		
Profil	Ölçü Li (mm)		Profil	Ölçü Li (mm)				
30 x 10	650	***	30 x 10	1050	***	32 x 10	1000	***
30 x 10	655	***	30 x 10	1180	***	32 x 10	1175	***
30 x 10	665	***	30 x 10	1200	***	32 x 10	1180	***
30 x 10	680	***	30 x 10	1320	***	32 x 10	1200	***
30 x 10	700	***	30 x 10	1500	***	32 x 10	1300	***
30 x 10	750	***	30 x 10	1600	***			
30 x 10	775	***	30 x 10	1800	***			
30 x 10	800	***						
30 x 10	850	***	32 x 10	750	***			
30 x 10	900	***	32 x 10	800	***			
30 x 10	950	***	32 x 10	850	***			
30 x 10	1000	***	32 x 10	900	***			
30 x 10	1025	***	32 x 10	950	***			

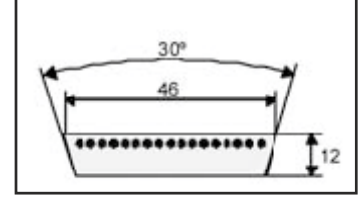

PROFİL 37 x 10			PROFİL 41 x 13					
Profil	Ölçü Li (mm)		Profil	Ölçü Li (mm)		Profil	Ölçü Li (mm)	
37 x 10	650	***	37 x 10	1320	***	41 x 13	1120	***
37 x 10	700	***	37 x 10	1400	***	41 x 13	1250	***
37 x 10	750	***	37 x 10	1500	***	41 x 13	1320	***
37 x 10	800	***	37 x 10	1600	***	41 x 13	1400	***
37 x 10	820	***	37 x 10	1700	***	41 x 13	1600	***
37 x 10	850	***	37 x 10	1800	***			
37 x 10	900	***						
37 x 10	950	***	41 x 13	900	***			
37 x 10	1020	***	41 x 13	925	***			
37 x 10	1060	***	41 x 13	950	***			
37 x 10	1120	***	41 x 13	1000	***			
37 x 10	1180	***	41 x 13	1040	***			
37 x 10	1250	***	41 x 13	1060	***			

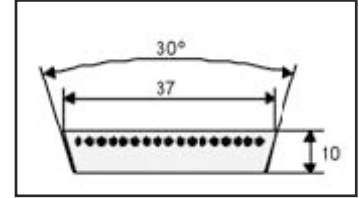

PROFİL 47 x 13			PROFİL 52 x 16					
Profil	Ölçü Li (mm)		Profil	Ölçü Li (mm)		Profil	Ölçü Li (mm)	
47 x 13	900	***	47 x 13	1750	***	52 x 16	2240	***
47 x 13	960	***	47 x 13	1800	***	52 x 16	2400	***
47 x 13	1000	***			***	52 x 16	2425	***
47 x 13	1060	***	52 x 16	1180	***			
47 x 13	1120	***	52 x 16	1250	***			
47 x 13	1180	***	52 x 16	1400	***			
47 x 13	1250	***	52 x 16	1525	***			
47 x 13	1320	***	52 x 16	1600	***			
47 x 13	1400	***	52 x 16	1625	***			
47 x 13	1500	***	52 x 16	1725	***			
47 x 13	1600	***	52 x 16	1800	***			
47 x 13	1650	***	52 x 16	1925	***			
47 x 13	1700	***	52 x 16	2165	***			

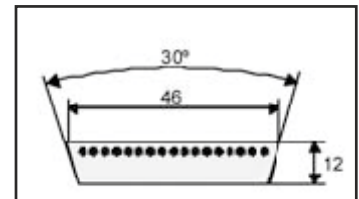

KAUÇUK VARYATÖR KAYIŞLARI

PROFİL 55 x 16						USD
Profil	Ölçü Li (mm)	\$	Profil	Ölçü Li (mm)		
55 x 16	1150	***	55 x 16	2240	***	
55 x 16	1180	***	55 x 16	2500	***	
55 x 16	1250	***				
55 x 16	1320	***				
55 x 16	1400	***				
55 x 16	1500	***				
55 x 16	1600	***				
55 x 16	1700	***				
55 x 16	1800	***				
55 x 16	1900	***				
55 x 16	2000	***				
55 x 16	2100	***				
55 x 16	2120	***				

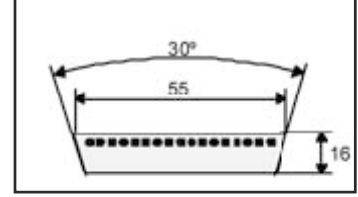

PROFİL 60 x 20 - 62 x 22 PROFİL 65 x 20					
Profil	Ölçü Li (mm)		Profil	Ölçü Li (mm)	
60 x 20	1320	***	65 x 20	1400	***
60 x 20	1550	***	65 x 20	1506	***
			65 x 20	1550	***
62 x 22	1745	***	65 x 20	1600	***
			65 x 20	1706	***
			65 x 20	1906	***
			65 x 20	2065	***
			65 x 20	2706	***



PROFİL 70 x 18			PROFİL 70 x 20			HEIDELBERG MATBAA		
Profil	Ölçü Li (mm)		Profil	Ölçü Li (mm)		Profil	Ölçü Li (mm)	
70 x 18	1600	***	70 x 20	1300	***	47 X 13	1700	***
70 x 18	1700	***	70 x 20	1450	***	47 X 13	1750	***
70 x 18	1800	***			***	47 X 13	1800	***
70 x 18	1900	***	73 x 20	1550	***			
70 x 18	2000	***				49 X 9	2190	***
70 x 18	2240	***	83 x 25	1680	***	49 X 9	2295	***
70 x 18	2500	***	83 x 25	2130	***	49 X 9	2750	***
70 x 18	2800	***	83 x 25	2380	***			
			83 x 25	2500	***			
			98 x 23	1836	***			

EKLEMELİ / LINK KAYIŞLAR

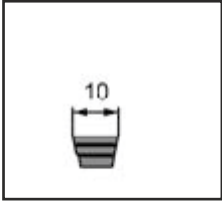
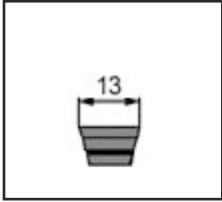

PowerTwist Plus[™]
V-BELTS
NU T LINK
SUPER T LINK

PROFİL ÖLÇÜLERİ

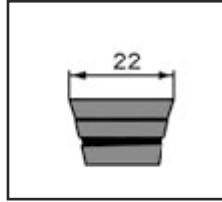
10/Z	13/A	17/B	22/C
			

POWER TWIST PLUS		NU T LINK		SUPER T LINK	
TİP	1 MT	TİP	1 MT	TİP	1 MT
10/ Z	***	10/ Z	***	SPA	***
13/ A	***	13/ A	***	SPB	***
17/ B	***	17/ B	***	SPC	***
22/ C	***	22/ C	***		



AÇIK UÇLU DELİKLİ V KAYIŞLARI

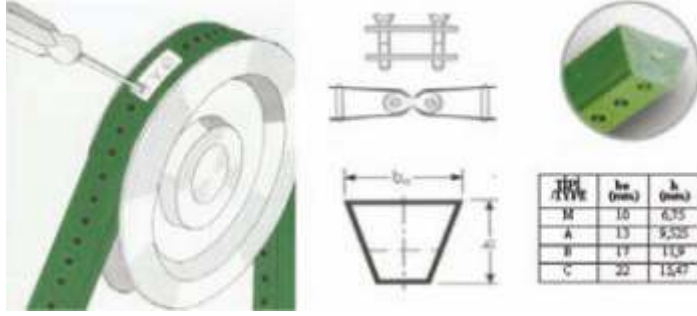

PROFİL ÖLÇÜLERİ

10/Z	13/A	17/B	22/C

KAYIŞ

TİP	1 MT
6 / Y	***
8 / M	***
10 / Z	***
13 / A	***
17 / B	***
22 / C	***



KİLİT

TİP	1 MT
6 / Y	***
8 / M	***
10 / Z	***
13 / A	***
17 / B	***
22 / C	***



Profil Y / Yellow (8mm)

BELT NO KAYIŞ NO	DİŞ TEETH	BOY (mm)	FİYAT 16 mm	EURO
Y 640	80	640	***	
Y 720	90	720	***	
Y 800	100	800	***	
Y 896	112	896	***	
Y 1000	125	1.000	***	
Y 1120	140	1.120	***	
Y 1200	150	1.200	***	
Y 1280	160	1.280	***	
Y 1440	180	1.440	***	
Y 1600	200	1.600	***	
Y 1792	224	1.792	***	
Y 2000	250	2.000	***	
Y 2240	280	2.240	***	
Y 2400	300	2.400	***	

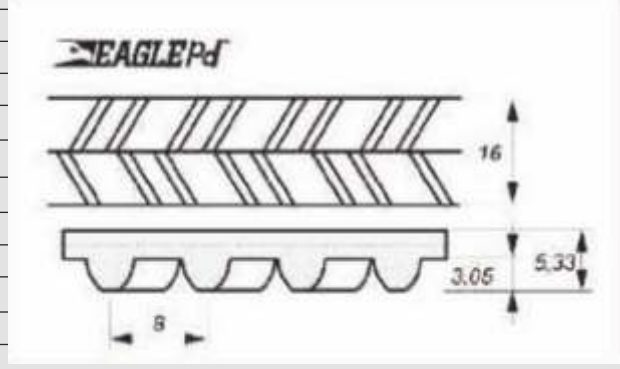

Profil W / White (8mm)

BELT NO KAYIŞ NO	DİŞ TEETH	BOY (mm)	FİYAT 32 mm	EURO
W 640	80	640	***	
W 720	90	720	***	
W 800	100	800	***	
W 896	112	896	***	
W 1000	125	1.000	***	
W 1120	140	1.120	***	
W1200	150	1.200	***	
W1280	160	1.280	***	
W1440	180	1.440	***	
W 1600	200	1.600	***	
W 1792	224	1.792	***	
W 2000	250	2.000	***	
W 2240	280	2.240	***	
W 2400	300	2.400	***	

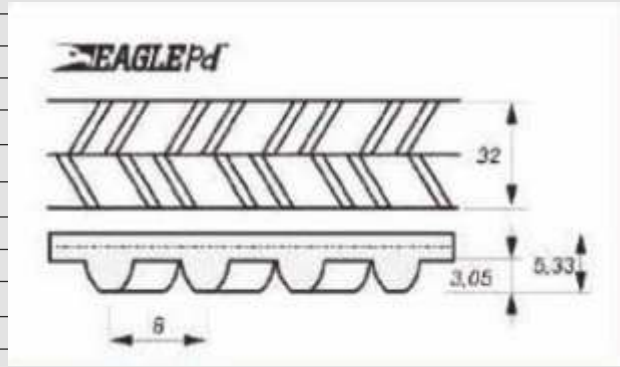

Profil P / Purple (8mm)

BELT NO KAYIŞ NO	DİŞ TEETH	BOY (mm)	FİYAT 64 mm	EURO
P 720	90	720	***	
P 800	100	800	***	
P 896	112	896	***	
P 1000	125	1.000	***	
P 1120	140	1.120	***	
P 1200	150	1.200	***	
P 1280	160	1.280	***	
P 1440	180	1.440	***	
P 1600	200	1.600	***	

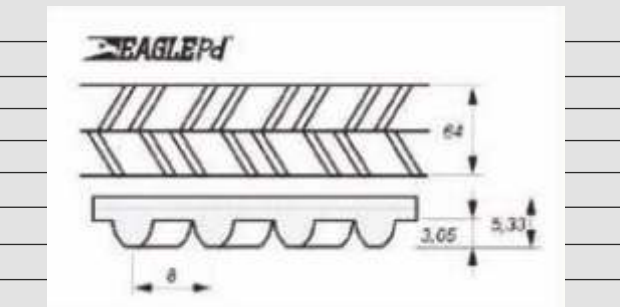

KAPLAMA KAYIŞLAR

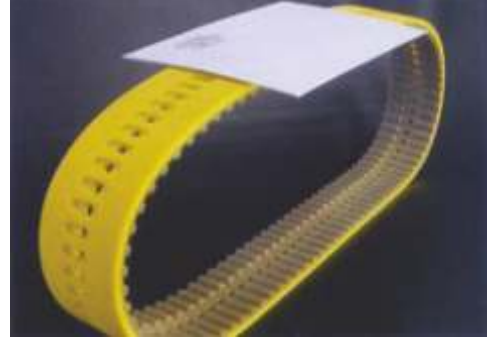

PROFİLİ KAYIŞLAR

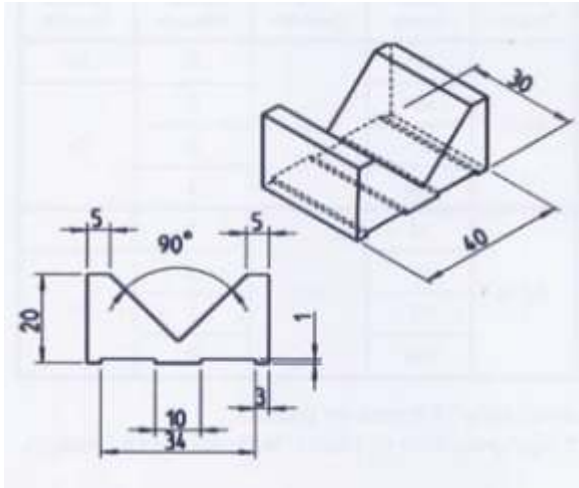

AÇIK UÇLU KAYIŞ YAPIŞTIRMA



AÇIK UÇLU KAYIŞ EKLEME



AÇIK UÇLU BAĞLANTI ELEMANLARI

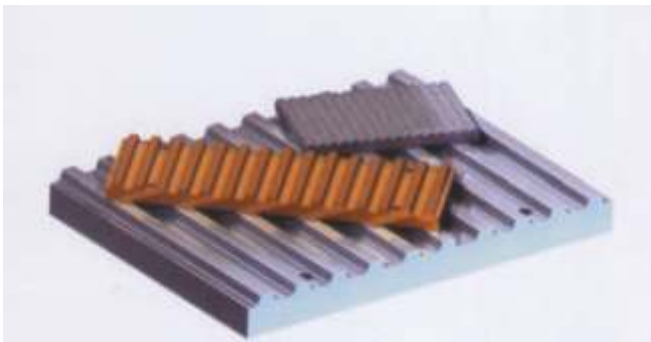

NEDENLER ÇÖZÜMLER VE ÖNLEYİCİ TEDBİRLER

SONUÇ	NEDENLER	YAPILMASI GEREKENLER
Kayış Çatlaması	<ol style="list-style-type: none"> 1. Aşırı yük 2. Hareketsizlik 3. Kasnağın çapı küçükse 4. Gerginlik 5. Kayışı katlamak,bükme ve uygunsuz kullanım 6. Şok yükü fazla ise 7. Kayışın kasnak yan kısımlarına tımanması 8. Aktarma sistemine kırık ya da yabancı maddelerin girmesi 	<ol style="list-style-type: none"> 1. Düzenek kontrol edilmeli,doğru kayış eni seçilmeli 2. Doğru kasnak tercih edilmeli 3. Diş oranlarının düzeneğe göre seçilmesi 4. İlk gerginliğin hazırlık aşamasında ayarlanması 5. Kayışın saklanması ve nakliyesinde dikkat edilmeli 6. Düzenek ayarları sonucu beklenmedik kazaların önlenmesi 7. Düzenek açılarının paralel olarak ayarlanması 8. Koruyucu kapağın doğru montajı ve yabancı maddelerin temizlenmesi
Kayış yüzeylerinin aşırı yıpranması veya yırtılması	<ol style="list-style-type: none"> 1. Kasnakların paralel değilse 2. Dönme hareketinin yeterli sabitlikte olmaması 3. Kasnak yan kısımlarının şekil dışı olması 4. Kasnak yan kısımlarını pürüzlü olması 5. Kayışın kasnak ve dişli koruyucu düzeneğini sürtmesi 	<ol style="list-style-type: none"> 1. Paralellik ayarlanmalı 2. Düzeneğin iyi montajı ve sabitliği kontrol edilmeli 3. Kasnak dış kulaklarının değişmesi yada tasarımı 4. Kasnak dış kulaklarının değişmesi yada tasarımı 5. Koruyucu kapak yada standın kontrol edilmesi
Kayış dişlerinin aşırı yıpranması veya yırtılması	<ol style="list-style-type: none"> 1. Aşırı yük 2. Yüksek ilk gerginlik 3. Kasnak dış yüzeyinin pürüzlü olması 4. Kasnağın birden fazla dikey hareketi 5. Toz ve kum parçacıkları 6. Şiddetli titreşim 7. Kasnak iç yüzeyine zararlı maddelerin girmesi 	<ol style="list-style-type: none"> 1. Düzeneğin kontrol edilerek,kayış eninin seçilmesi 2. İlk gerginliğinin uygun olarak ayarlanması 3. Aktarma düzeneğ yüzeylerinin pürüzleri kontrol edilmeli 4. Dikey zıplamalar önlenmeli ve ayarlanmalı 5. Yabancı maddelerden düzeneği korumak 6. Titreşim önlenmeli ve düzeneğ sabitliği sağlanmalıdır 7. Çevre temizliğine dikkat edilmeli
Diş kesilmesi	<ol style="list-style-type: none"> 1. Aşırı yük ve ani yük etkisi 2. Gerekli diş sayısının yeterli olmaması, en az 6 diş eksik olması veya kayış diş sayısının kasnak diş sayısının katlarından az olması 3. Aşırı ilk gerginlik 4. Kasnak çapının çok küçük olması 5. Çevre sıcaklığının aşırı yüksek olması yada yağ ve diğer materyallerin araya dolması 6. Beklenmedik kazalar sonucu aktarmanın durması ve ani yük birikmesi 	<ol style="list-style-type: none"> 1. Düzeneğ kontrol edilmeli 2. Kayış diş sayısı kontrol edilerek,tek sayı adet olarak seçilmelidir. 3. İlk gerginlik ayarlanmalıdır 4. Kasnak çapı büyütülmelidir 5. Çevre sıcaklığı uygun dereceye düşürülmeli ve koruyucu düzeneğ ayarlanmalıdır 6. Düzeneğ içindeki sistemler kontrol edilmeli, kaza önlenmelidir
Kayışın dikey çatlama	<ol style="list-style-type: none"> 1. Kayışın kasnak dışında yürümesi 2. Kayışın kasnak dış kulaklarına tımanması 3. Kayışın düzeneğe uygulanırken,kasnak dış kulaklarına oturtulması. 	<ol style="list-style-type: none"> 1. Paralellik ayarlanmalıdır 2. Paralellik ayarlanmalı ve kasnak yan kulakları kontrol edilmelidir 3. Düzeneğ hassas monte edilmelidir
Kayış uzaması	<ol style="list-style-type: none"> 1. Aktarma sistemlerinin yanlış montajı sonucu,çalışma esnasında uzaklıkların fark göstermesi 2. Direnç elemanlarının yeterli olmaması 3. Kasnak gerginliğinin yeterli olmaması 4. Kasnak yüzeyindeki sorunlar 5. Aşırı yük 	<ol style="list-style-type: none"> 1. Montaj hassas yapılmalı ve dizayn yapılırken keskinlik göz önüne alınmalıdır 2. Kayış değiştirilmeli 3. Montaj esnasında gergi kasnağı hassas takılmalı 4. Kasnak değiştirilmeli 5. Düzeneğ kontrol edilerek,gerekliyse kayış eni değiştirilmeli
Kayış çatlaklarında ve yüzeylerde yumuşama	<ol style="list-style-type: none"> 1. Çevre sıcaklığının aşırı yükselmesi 	<ol style="list-style-type: none"> 1. Çevre sıcaklığı uygun şartlara düşürülmelidir
Aktarma düzeneğindeki aşırı ses	<ol style="list-style-type: none"> 1. Aşırı yük 2. İlk gerginliğin yüksek olması 3. Kasnakların paralel olmaması 4. Kasnak çapının kayış eninden daha düşük olması 5. Kayış dişlerinin iç yüzey kaplama sorunları 	<ol style="list-style-type: none"> 1. Düzeneğ yeniden tasarlanmalıdır 2. İlk gerginlik yeniden ayarlanmalıdır 3. Paralellik ayarlanmalı,montaj tam hassas takılmalı 4. Düzeneğ kontrol edilmelidir 5. Kayış ve kasnak kontrol edilmelidir