

GRUP

MAKİNE VE HIRDAVAT MALZEMELERİ
SANAYİ VE TİCARET LİMİTED ŞİRKETİ

ÜRÜN
KATALOĞU
PRODUCT CATALOGUE



- KAUÇUK ÜRÜNLER
- TEKSTİL YEDEK PARÇALARI
- SİLİKON ÜRÜNLER

1997'den Bugüne

Hızlı ve Kaliteli Çözümler Üretiriz...

ÜRÜN GRUPLARIMIZ

İÇİNDEKİLER / *Index*

SAYFA / *Page*

- | | |
|---|--------|
| • RAM ve SANFOR İĞNELERİ | 1-2 |
| • RAM ve SANFOR FIRÇALARI | 3 |
| • SANFOR KALIP ve MAKARALARI | 4 |
| • TAMBUR LASTİKLERİ | 5 |
| • YIKAMA - CAM VE KAPAK LASTİKLERİ | 6 |
| • KAPAK LASTİKLERİ | 7 |
| • KAZAN KAPAK LASTİKLERİ | 8-9-10 |
| • ISI YALITIM FİTİLLERİ | 11 |
| • SIYIRICI LASTİKLER | 12 |
| • MUHTELİF PROFİL LASTİKLERİ | 13-14 |
| • KAPAK CONTALARI | 15 |
| • VANA DİYAFRAM VE CONTALARI | 16 |
| • UÇ BULMA MIKNATISLARI | 17 |
| • SİLİKON SÜNGER - LAMA / EPDM - EVA PLAKALAR | 17 |



MONFORTS 25 İĞNELİ PLAKA



MONFORTS 40 İĞNELİ PLAKA

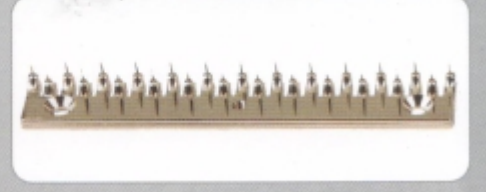

MONFORTS 40 İĞNELİ PLAKA



MONFORTS KENARDAN BAĞLANTILI PİMSİZ MODEL

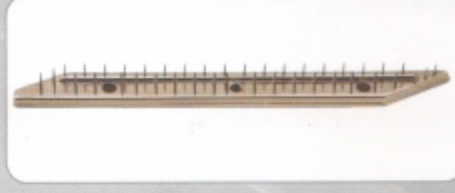

BABCOCK 40 İĞNELİ PİMLİ ORTADAN SIKMALI PLAKA SAĞ

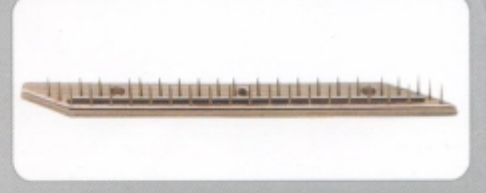

BABCOCK 40 İĞNELİ PİMLİ ORTADAN SIKMALI PLAKA SOL



BABCOCK DİKEY ZİNCİR 21 İĞNELİ PLAKA



TEXTİMA 29 İĞNELİ PLAKA



TEXTİMA 24 İĞNELİ PLAKA TERS DERECE



EHWA 38 İĞNELİ BAĞLANTI 73 MM PLAKA SAĞ



EHWA 38 İĞNELİ BAĞLANTI 73 MM PLAKA SOL

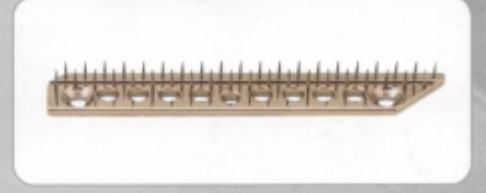

EHWA 38 İĞNELİ BAĞLANTI 73 MM PLAKA SOL



LAFER 16 İĞNELİ PLAKA



EHWA 38 İĞNELİ BAĞLANTI 76 MM PLAKA SOL



BRÜCKNER 36 İĞNELİ YENİ TİP PLAKA



BRÜCKNER 36 İĞNELİ PLAKA İĞNE ARASI DALGA SETLİ TİP



BRÜCKNER 20 İĞNELİ TARAK TİP PLAKA



BRÜCKNER 19 İĞNELİ TARAK TİP PLAKA

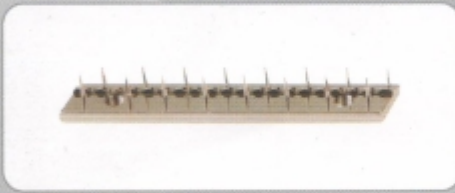

BRÜCKNER 16 İĞNELİ PLAKA İĞNE ARASI SETLİ

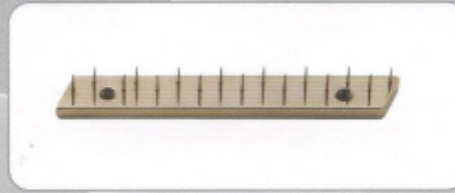

BRÜCKNER 16 İĞNELİ PLAKA

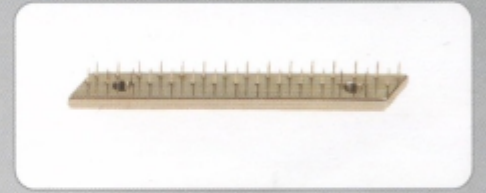

BRÜCKNER 30 İĞNELİ PLAKA

RAM ve SANFOR İĞNELERİ

GRUP

MAKİNE VE HIRDAVAT MALZEMELERİ
SANAYİ VE TİCARET LİMİTED ŞİRKETİ



BRÜCKNER 12 İĞNELİ KAMBUR TİP PLAKA



SANTEX 16 İĞNELİ PLAKA



ARTOS 40 İĞNELİ PLAKA SAĞ

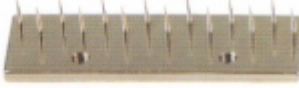

SPERETTO, S.LUCIA 14 İĞNELİ PLAKA



STANTER 20 İĞNELİ PLAKA



ALEA 20 İĞNELİ PLAKA



MERSERİZE 11 İĞNELİ PLAKA



FERRARO 11 İĞNELİ PLAKA



ARTOS 40 İĞNELİ PLAKA SOL



LABARATUAR 11 İĞNELİ PLAKA



UNITECH 28 İĞNELİ PLAKA SAĞ



ARTOS TARAK TİP 28 İĞNELİ PLAKA



ARTOS TARAK TİP 28 İĞNELİ PLAKA



FAMATEX 28 İĞNELİ MEMELİ M - 4 BAĞLANTILI MODELİ



FAMATEX 28 İĞNELİ MEMELİ BAĞLANTILI HIZLI KİLİT MODELİ

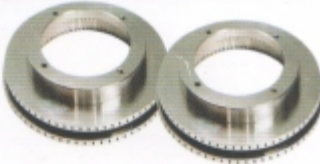

BRÜCKNER BASTON İĞNELİ DİSK



BRÜCKNER İĞNELİ DİSK

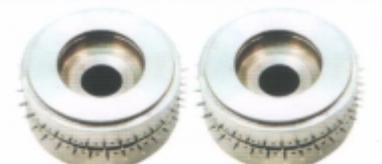

SANFOR İĞNELİ DİSK



MONFORTS İĞNELİ DİSK

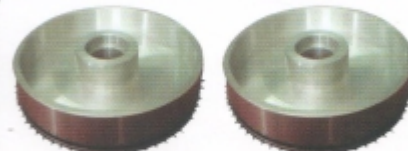

FERRARRO İĞNELİ DİSK



KRANTZ İĞNELİ DİSK



BRUCKNER RAM FIRÇASI



BRUCKNER RAM FIRÇASI



BRUCKNER RAM FIRÇASI



MONFORST RAM FIRÇASI



MONFORST RAM FIRÇASI



SANFOR FIRÇA



BAKLA FIRÇA KAYIŞLI 43'LÜ



BAKLA FIRÇA

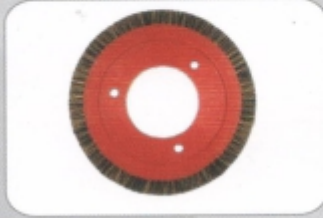

EHWHA - LK RAM FIRÇASI



İL SUNG RAM FIRÇASI



KRANTZ RAM FIRÇASI



TEXTİMA RAM FIRÇASI



ACC ALKAN RAM FIRÇASI



ACC ALKAN RAM FIRÇASI



ACC ALKAN RAM FIRÇASI



FAMATEX RAM FIRÇASI



SANTEX RAM FIRÇASI



BABCOCK RAM FIRÇASI



ÖZEL FIRÇALAR

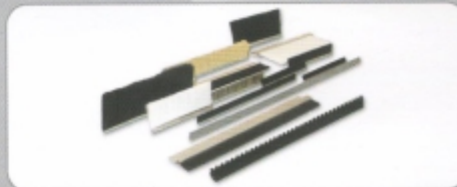

ŞERİT FIRÇALAR



SİLİNDİR FIRÇALAR



TEKSTİL FIRÇALARI



Makineler için yedek parçalar

- Tüp kumaş ütü/sanfor kalıpları ve tüm makara çeşitleri
- Ütü keçesi
- Buhar başlığı
- Vulkalon kaplama makaralar
- Varyatör kasnak ve kayışları
- Otomatik Heliot ütü ve sanfor kalıpları
- Balaban kumaş kurutma buhar başlıkları
- Otomatik yağ açma kalıpları
- Çeşitli mahrutli kutular
- Miknatıslı kalıplar
- Neodyum miknatıslı

Spare parts for machines

- Tube type fabric's ironing moulds & all spool types
- Ironing felts
- Clynder steam tool
- Coated spools by vulkalion
- Embodary & belt
- Automatic iron & sanfors stretcher
- Fabric drying & steam header
- Automatic wet opening stretcher
- Magnetical strecher
- Neodyum magnet

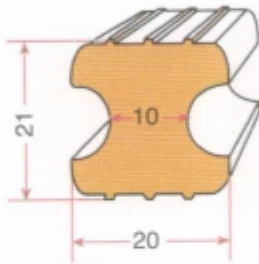

İÇ TAMBUR LASTİĞİ
GRP 0028

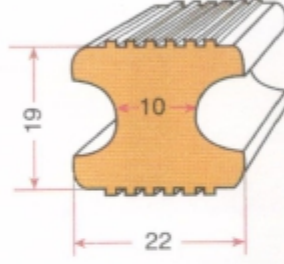

İÇ TAMBUR LASTİĞİ
GRP 0985

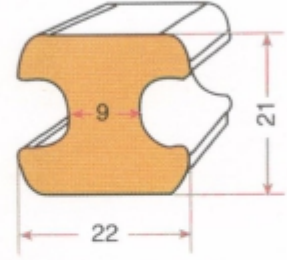

İÇ TAMBUR LASTİĞİ
GRP 1196

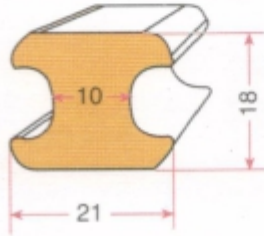

İÇ TAMBUR LASTİĞİ
GRP 1444

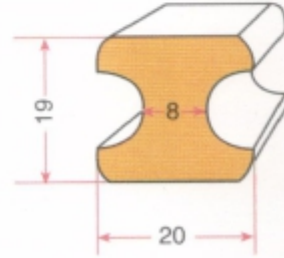

İÇ TAMBUR LASTİĞİ
GRP 0984

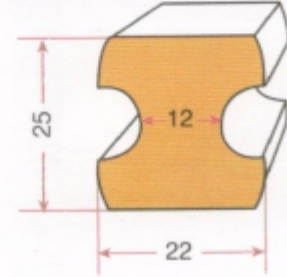

İÇ TAMBUR LASTİĞİ
GRP 0433

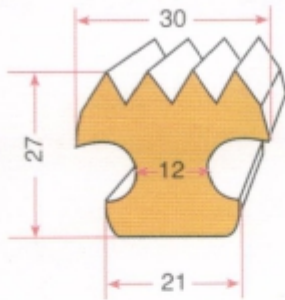

İÇ TAMBUR LASTİĞİ
GRP 0996

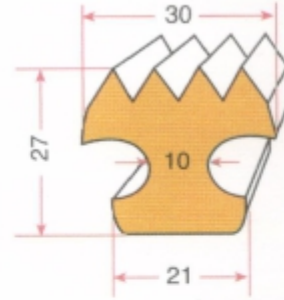

İÇ TAMBUR LASTİĞİ
GRP 0885

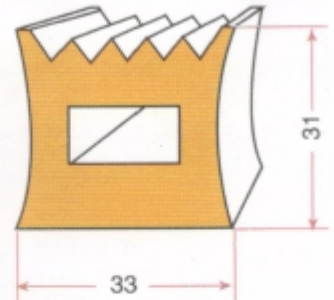

DIŞ TAMBUR LASTİĞİ
GRP 0182

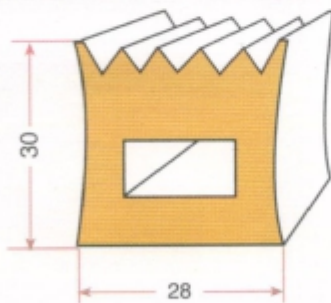

DIŞ TAMBUR LASTİĞİ
GRP 1197

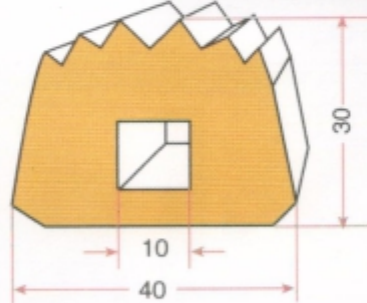

DIŞ TAMBUR LASTİĞİ
GRP 0845

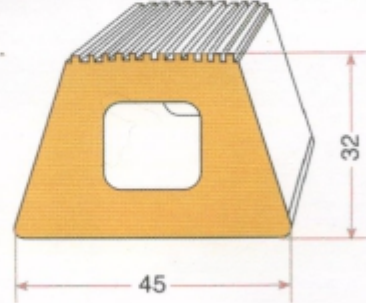

DIŞ TAMBUR LASTİĞİ
GRP 1178

YIKAMA - CAM VE KAPAK LASTİKLERİ

GRUP

MAKİNE VE HIRDAVAT MALZEMELERİ
SANAYİ VE TİCARET LİMİTED ŞİRKETİ





KAZAN KAPAK LASTİKLERİ

GRUP

MAKİNE VE HIRDAVAT MALZEMELERİ
SANAYİ VE TİCARET LİMİTED ŞİRKETİ



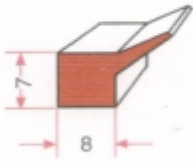

KAZAN KAP. LASTİĞİ
GRP 0994

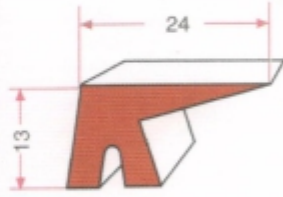

KAZAN KAP. LASTİĞİ
GRP 0451

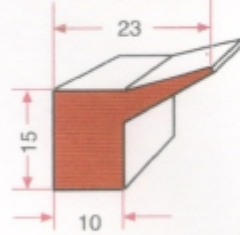

KAZAN KAP. LASTİĞİ
GRP 0626



KAZAN KAP. LASTİĞİ
GRP 1549

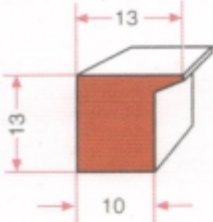

KAZAN KAP. LASTİĞİ
GRP 0452

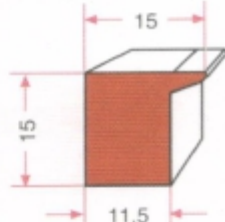

KAZAN KAP. LASTİĞİ
GRP 0628

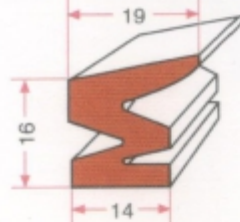

KAZAN KAP. LASTİĞİ
GRP 0876

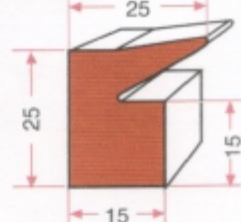

KAZAN KAP. LASTİĞİ
GRP 0755

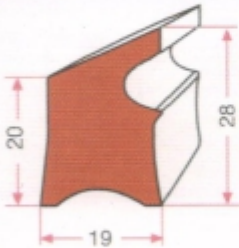

KAZAN KAP. LASTİĞİ
GRP 1203

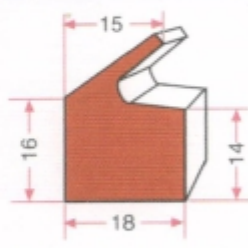

KAZAN KAP. LASTİĞİ
GRP 1380

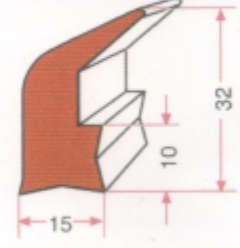

KAZAN KAP. LASTİĞİ
GRP 0443

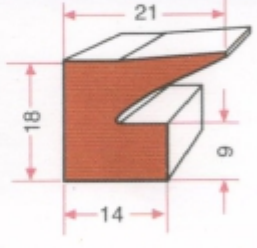

KAZAN KAP. LASTİĞİ
GRP 0444

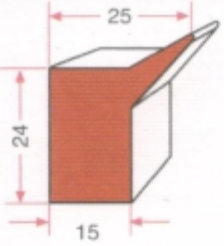

KAZAN KAP. LASTİĞİ
GRP 0725

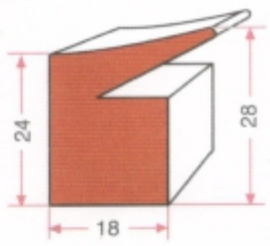

KAZAN KAP. LASTİĞİ
GRP 1212



KAZAN KAP. LASTİĞİ
GRP 0907

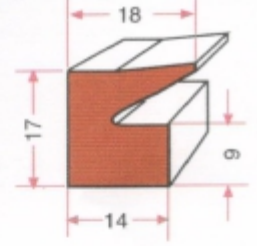

KAZAN KAP. LASTİĞİ
GRP 0447

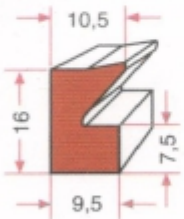

KAZAN KAP. LASTİĞİ
GRP 0688

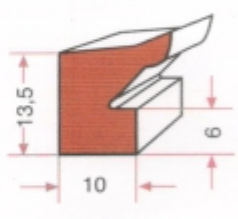

KAZAN KAP. LASTİĞİ
GRP 1698

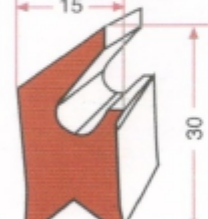

KAZAN KAP. LASTİĞİ
GRP 0630

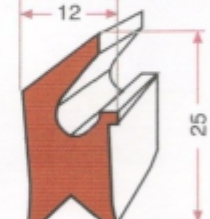

KAZAN KAP. LASTİĞİ
GRP 0818

KAZAN KAPAK LASTİKLERİ

GRUP

MAKİNE VE HIRDAVAT MALZEMELERİ
SANAYİ VE TİCARET LİMİTED ŞİRKETİ



KAZAN KAP. LASTİĞİ
GRP 0726

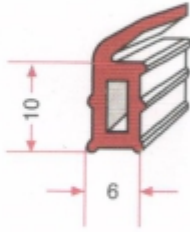

KAZAN KAP. LASTİĞİ
GRP 0413



KAZAN KAP. LASTİĞİ
GRP 1170



KAZAN KAP. LASTİĞİ
GRP 1694

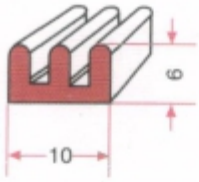

KAZAN KAP. LASTİĞİ
GRP 0843

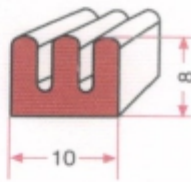

KAZAN KAP. LASTİĞİ
GRP 1719

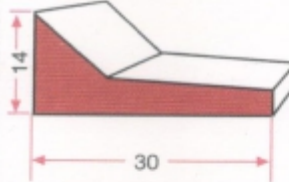

KAZAN KAP. LASTİĞİ
GRP 1284

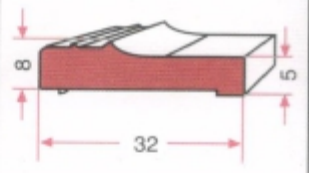

KAZAN KAP. LASTİĞİ
GRP 0029

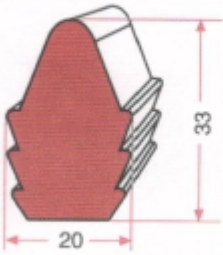

KAZAN KAP. LASTİĞİ
GRP 1495

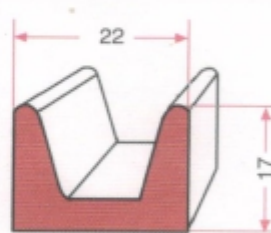

KAZAN KAP. LASTİĞİ
GRP 1059

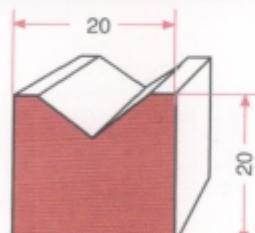

KAZAN KAP. LASTİĞİ
GRP 1126

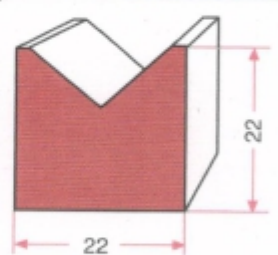

KAZAN KAP. LASTİĞİ
GRP 1239



KAZAN KAP. LASTİĞİ
GRP 0793

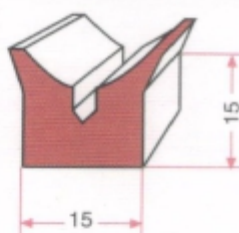

KAZAN KAP. LASTİĞİ
GRP 0904



KAZAN KAP. LASTİĞİ
GRP 0439



KAZAN KAP. LASTİĞİ
GRP 1754

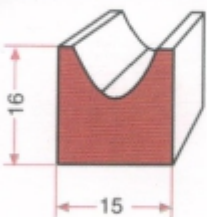

KAZAN KAP. LASTİĞİ
GRP 0791

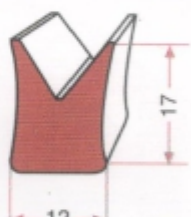

KAZAN KAP. LASTİĞİ
GRP 0437

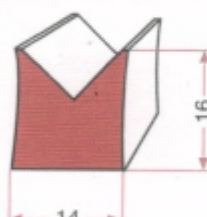

KAZAN KAP. LASTİĞİ
GRP 0436

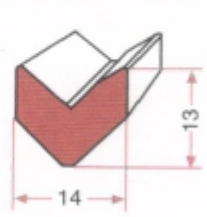

KAZAN KAP. LASTİĞİ
GRP 0438

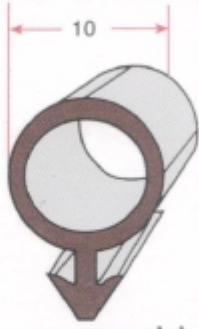

ISI YALITIM FİTİLİ
GRP 0750



ISI YALITIM FİTİLİ
GRP 0750

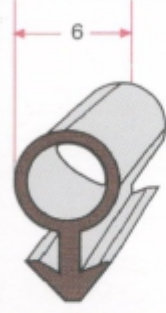

ISI YALITIM FİTİLİ
GRP 0750

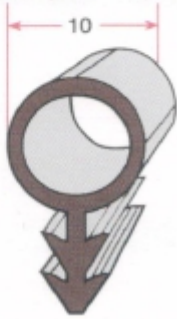

ISI YALITIM FİTİLİ
GRP 0750



ISI YALITIM FİTİLİ
GRP 0750



ISI YALITIM FİTİLİ
GRP 0750



ISI YALITIM FİTİLİ
GRP 0750



ISI YALITIM FİTİLİ
GRP 0750



ISI YALITIM FİTİLİ
GRP 0750

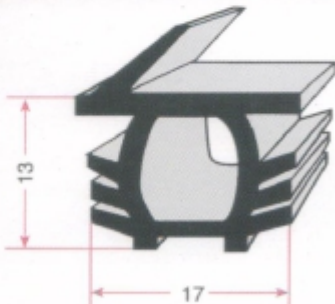

ÇELİK KAPI LASTİĞİ
GRP 0900

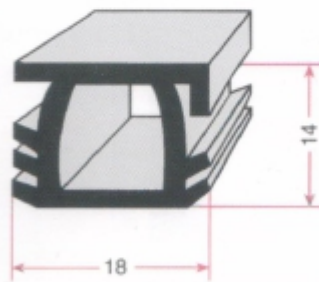

ÇELİK KAPI LASTİĞİ
GRP 0261

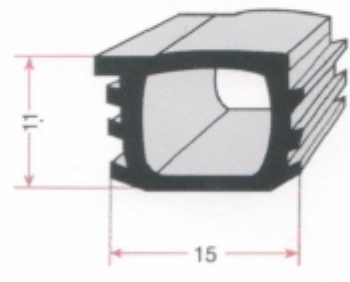

ÇELİK KAPI LASTİĞİ
GRP 0749

SIYIRICI LASTİKLERİ

GRUP

MAKİNE VE HIRDAVAT MALZEMELERİ
SANAYİ VE TİCARET LİMİTED ŞİRKETİ

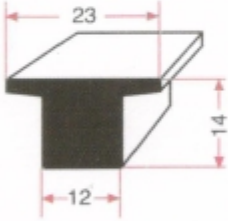

T. CONTA LASTİĞİ
GRP 0790



T. SIYIRICI LASTİK
GRP 0815

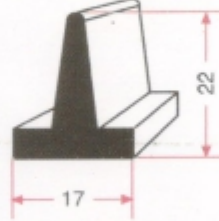

T. SIYIRICI LASTİK
GRP 1070

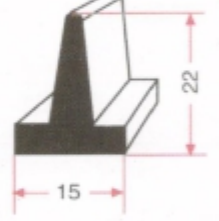

T. SIYIRICI LASTİK
GRP 0225



T. SIYIRICI LASTİK
GRP 0816



T. SIYIRICI LASTİK
GRP 1324

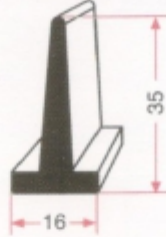

T. SIYIRICI LASTİK
GRP 0814

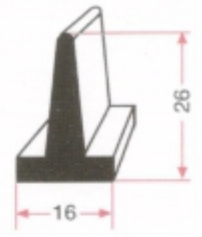

T. SIYIRICI LASTİK
GRP 0813

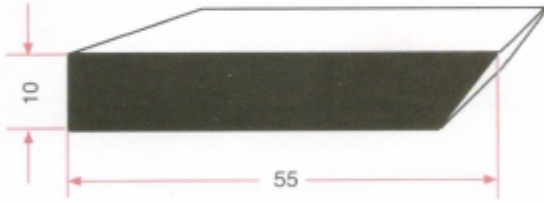

GRP 0022

SIYIRICI LASTİK

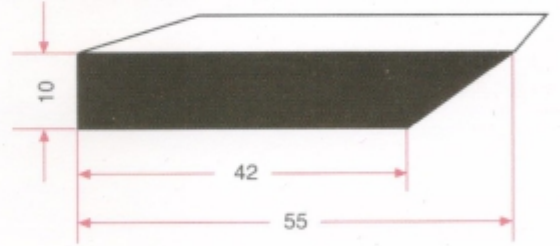

SIYIRICI LASTİK

GRP 1022

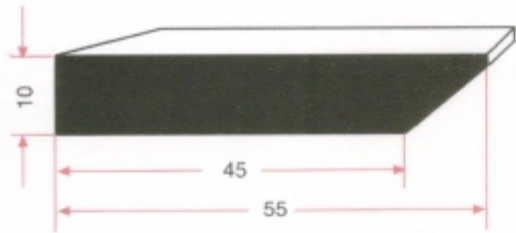

GRP 1153

SIYIRICI LASTİK

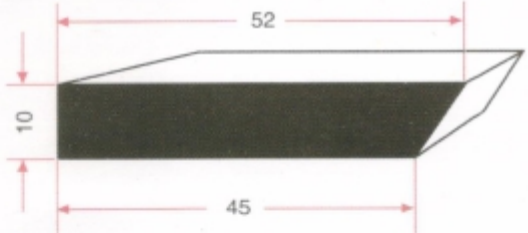

SIYIRICI LASTİK

GRP 1261

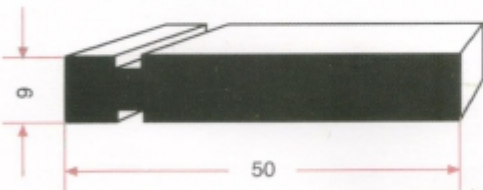

GRP 0667

SIYIRICI LASTİK

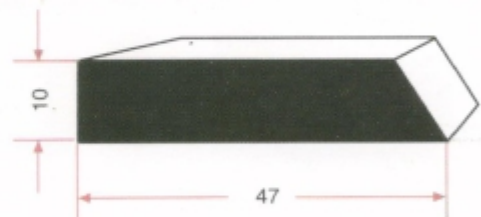

SIYIRICI LASTİK

GRP 1734

MUHTELİF PROFİL LASTİKLERİ

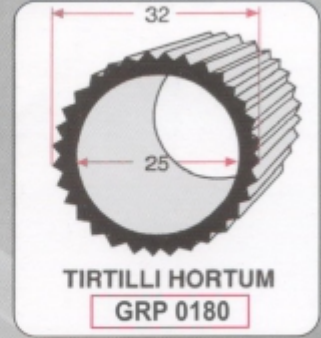

MUHTELİF PROFİL LASTİKLERİ

GRUP

MAKİNE VE HIRDAVAT MALZEMELERİ
SANAYİ VE TİCARET LİMİTED ŞİRKETİ

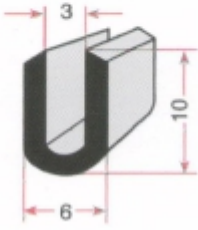

U LASTİĞİ
GRP 0056



U LASTİĞİ
GRP 0611



U LASTİĞİ
GRP 0401

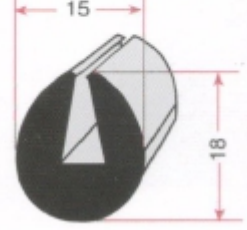

U LASTİĞİ
GRP 0926

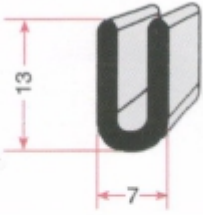

U LASTİĞİ
GRP 0235

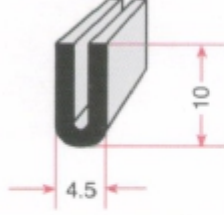

U LASTİĞİ
GRP 0914



U LASTİĞİ
GRP 0879



U LASTİĞİ
GRP 0055

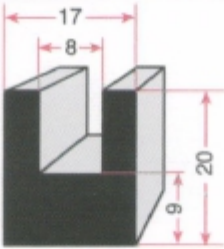

U LASTİĞİ
GRP 1040

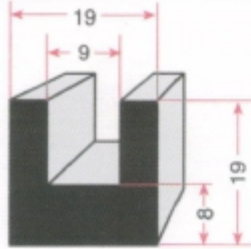

U LASTİĞİ
GRP 0937

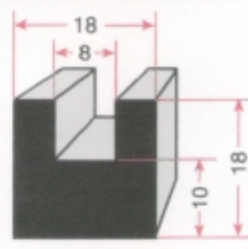

U LASTİĞİ
GRP 1187

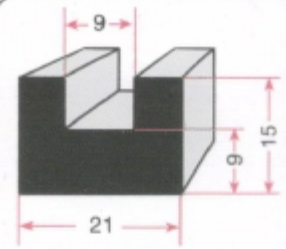

U LASTİĞİ
GRP 0229

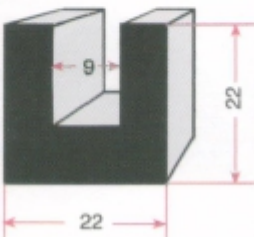

U LASTİĞİ
GRP 0387



ELEK LASTİĞİ
GRP 0405



ELEK LASTİĞİ
GRP 1085



ELEK LASTİĞİ
GRP 0404



ELEK LASTİĞİ
GRP 0045

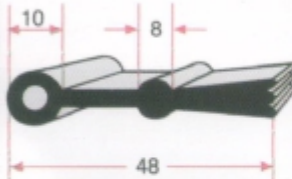

CONTA LASTİĞİ
GRP 0469

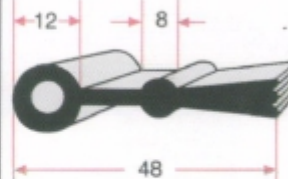

CONTA LASTİĞİ
GRP 0981

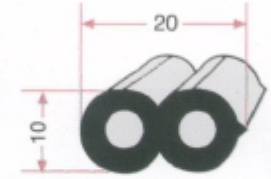

CONTA LASTİĞİ
GRP 0597

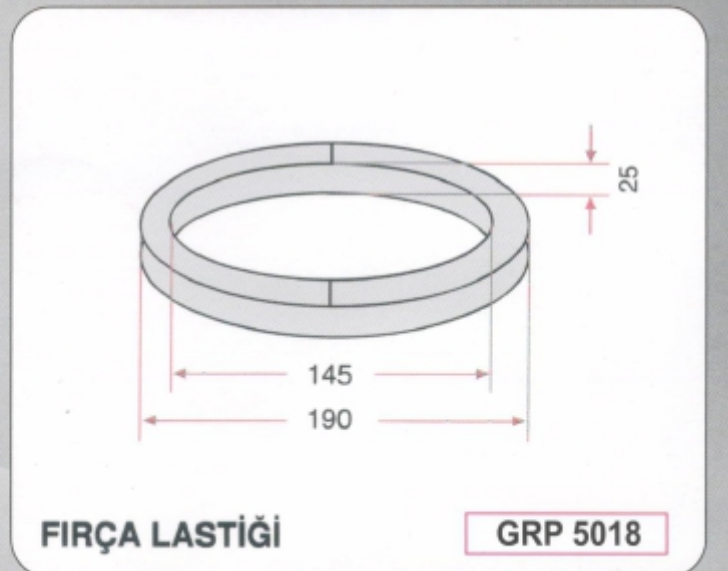
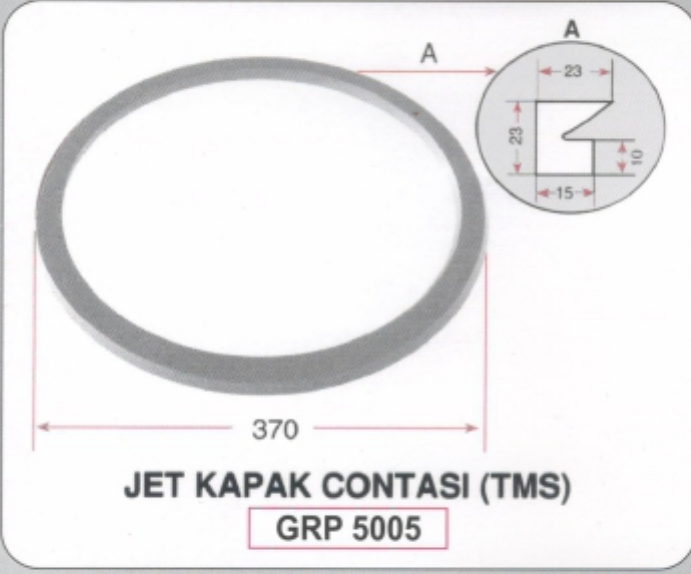

VANA DİYAFRAM VE CONTALARI

GRUP

MAKİNE VE HIRDAVAT MALZEMELERİ
SANAYİ VE TİCARET LİMİTED ŞİRKETİ

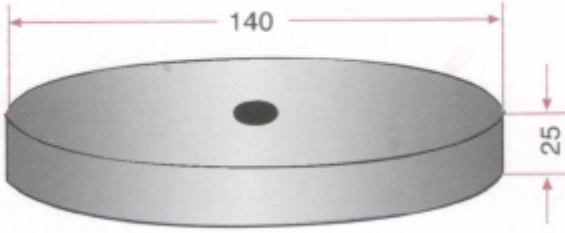

VANA CONTASI
GRP 5027

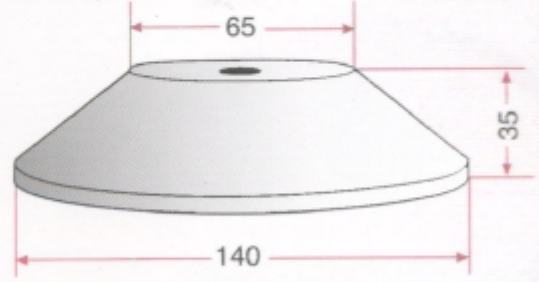

VANA CONTASI
GRP 5002

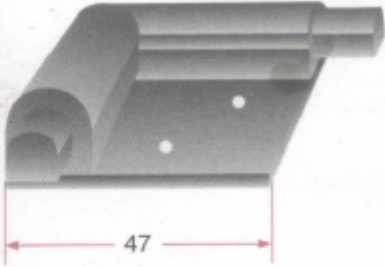

RAMÖZ KAPAK KÖŞE LASTİĞİ
GRP 5013

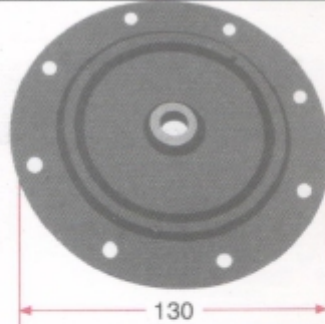

VANA DİYAFRAMI
GRP 5026

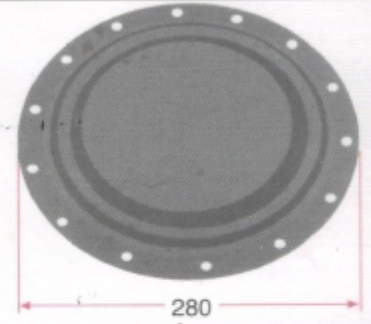

VANA DİYAFRAMI
GRP 5003

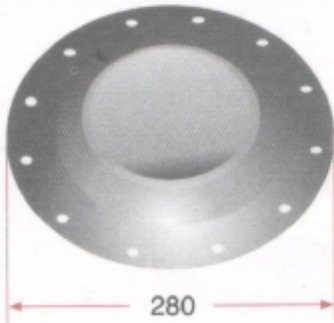

VANA DİYAFRAMI
GRP 5027

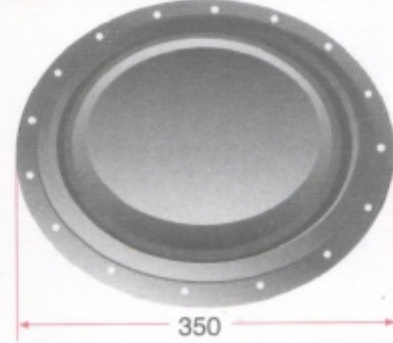

VANA DİYAFRAMI
GRP 5008

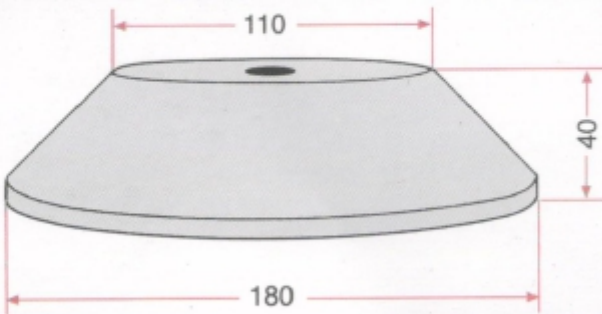

VANA CONTASI
GRP 5016

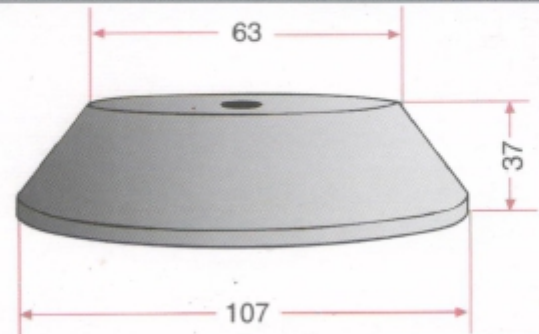

VANA CONTASI
GRP 5007

SİLİKON UÇ BULMA MIKNATISLARI

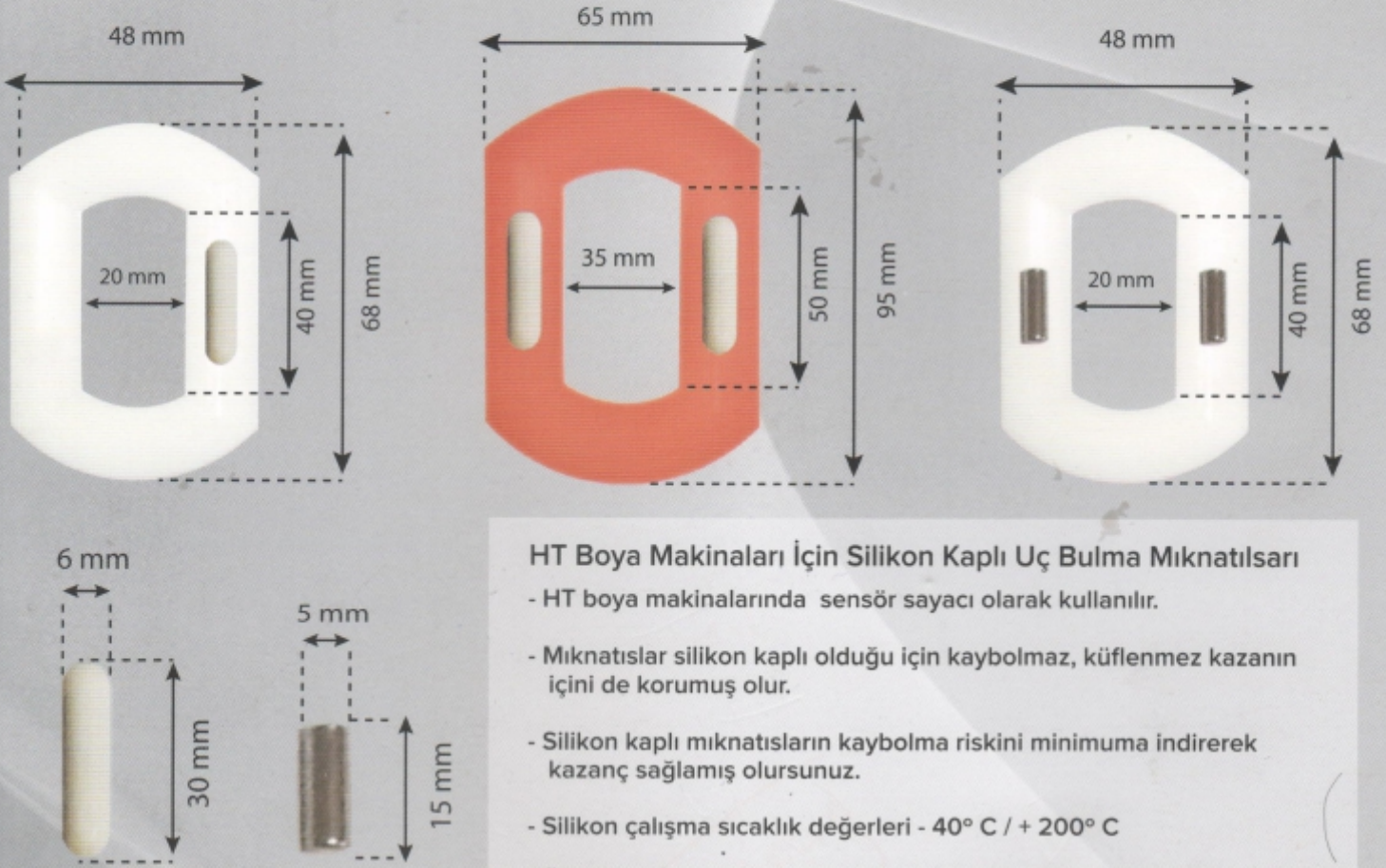

HT Boya Makinaları İçin Silikon Kaplı Uç Bulma Miknatısları

- HT boya makinalarında sensör sayacı olarak kullanılır.
- Miknatıslar silikon kaplı olduğu için kaybolmaz, küflenmez kazanın içini de korumuş olur.
- Silikon kaplı miknatısların kaybolma riskini minimuma indirerek kazanç sağlamış olursunuz.
- Silikon çalışma sıcaklık değerleri - 40° C / + 200° C
- Ölçü bilgileri için teknik departmanımızdan bilgi alabilirsiniz.

SİLİKON SÜNGER - LAMA / EPDM - EVA PLAKALAR



SİLİKON SÜNGER PLAKA

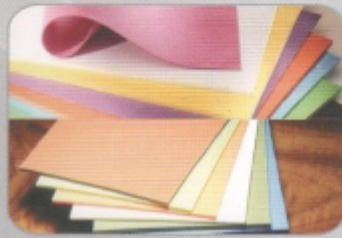

EVA TABAKA



EPDM PLAKA

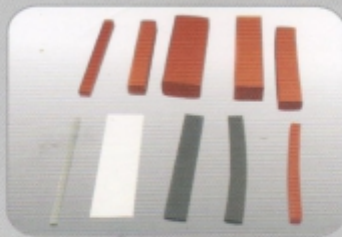

SİLİKON SÜNGER LAMA



SİLİKON PLAKA

Ölçü bilgileri için teknik departmanımızdan bilgi alabilirsiniz



GRUP

**MAKİNE VE HIRDAVAT MALZEMELERİ
SANAYİ VE TİCARET LİMİTED ŞİRKETİ**

www.grupmakina.com.tr

Cemaliye Mah. Gaziçeşme Sk. No: 8/A • 59860 Çorlu / Tekirdağ / TÜRKİYE
Tel: +90 (282) 654 00 04 (pbx) • Faks: +90 (282) 654 00 05

